

Design of Class-E Rectifier with DC-DC Boost Converter

F. K. A. Rahman, S. Saat, L. H. Zamri, N. M. Husain, N. A. Naim, S. A. Padli
Faculty of Electronic and Computer Engineering (FKEKK),
Universiti Teknikal Malaysia Melaka (UTeM), Malaysia.
shakir@utem.edu.my

Abstract— This paper presents the design of Class-E rectifier with dc-to-dc boost converter. In this paper, Class E synchronous rectifier that regulates the output voltage at a fixed switching frequency of 1 MHz is presented by a dc-dc power conversion. The experimental prototype has been built and evaluated. The converter achieved 83.33 percent efficiency with less than 5 percent of ripple percentage of the rectifier. This integrated power converter with class E rectifier provides a low loss operation suitable for Very High Frequency (VHF) applications.

Index Terms— Class E, Boost Converter, Rectifier, Circuit.

I. INTRODUCTION

Modern world nowadays expects researchers and scientists to be more creative in dealing with technologies. The power of technology encourages more people to do research in depth. Electronic field, on the other hand, enhances greatly by electronic components. The usage of electronic components in a power system receives a detailed focus nowadays as power electronics have the advantages of reducing area and power consumption; hence, saving more energy and becoming more user-friendly. Because of its benefits in the enhancement of high-frequency, high-efficiency, and low noise rectification [1], Class-E has been utilized for several functions including as a power amplifier. A simple Class-E power amplifier is made up of a single switch device which can be operated at a carrier frequency of the output signal and a load network that must only allow a single spectral frequency component [2], [3]. This paper concerns on the establishment of Class-E rectifier circuit that will be used for building a 12-V boost converter for Very High Frequency (VHF, 30-300MHz) applications[4].

A. Class-E Rectifier

A rectifier circuit has been established to convert an ac voltage input to a dc voltage output [5]. In Class-E rectifier, the transistor operates as a switch, and it is categorized as a family of soft-switching inverters. To produce a very high efficiency, the current and voltage waveforms of the switch are displaced with respect to time. In other words, the switch is on at zero voltage if the component values of the resonant circuit are suitably selected. Switching losses are virtually zero voltage as the switch current and voltage waveforms do not overlap during the switching time intervals; therefore, produces high efficiency [1].

According to [6], a Class-E rectifier with parallel capacitor is as shown in Figure 1. The rectifier consists of a diode, a resonant capacitor that is connected to diode (switch) in parallel, an inductor, and a filter that is connected in parallel. When the AC source V_R and the rectifier are coupled, they are able to provide the desired AC-to-DC voltage. In this case, the 12V AC is supplied to the rectifier to obtain 5V DC. The rectifier will act as a medium to convert to DC. When the diode is off, the inductor and capacitor will form series of resonant circuit. The current will flow through the capacitor and the capacitor will then store energy until the current decreases to zero. In contrast, when the diode is on, the current will flow through a smaller resistance, which is the diode. At this state, the current at the capacitor will fall to zero.

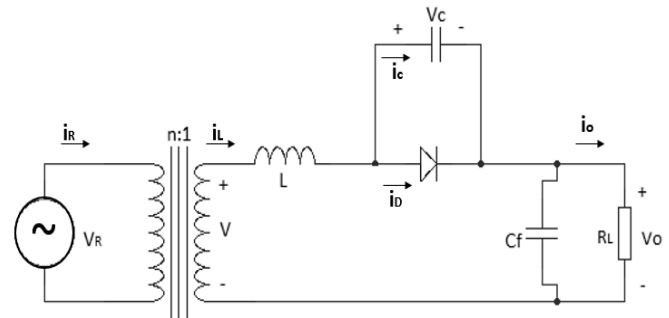

Figure 1: Basic circuit of Class-E rectifier circuit [6]

Based on [7], the design of Class-E rectifier was made based on two assumptions: firstly, the diode and the sinusoidal current source of the rectifier are ideal; and secondly, the dc current I_o through the output filter inductance is neglected. This paper highlights the advantages of having a design topology such as the absorption of a transistor output capacitance and the winding capacitance, the ability of the other capacitors to absorb the rectifier-diode junction capacitance, and the winding capacitance of second inductor. By having these characteristics, leakage inductance of the transformer of the circuit could be eliminated.

Furthermore, there is a need for a power conversion circuit to have zero voltage switching (ZVS) characteristics. The definition of this term can best be described as the typical square wave power conversion during on-time of the switch with resonant transitions of switching process [8]. Work in [9] proved that the existing advantages of Class-E converter can be preserved, while enhancing other parts, such as getting rid of stress of the resonant tank components caused by the current

values and peak voltages. Moreover, the new topology is also able to have zero-voltage switching (ZVS) when turning on and off, permitting the circuit to minimize power loss in the switching process.

B. Boost Converter

A boost converter is a type of converter, in which the output voltage is larger than the input. This is another type of switching converter that operates by turning on and off an electronic switch periodically [5]. Many appliances, including the dc-to-de converters can be switched on by using the switch mode supplies. The available voltage is often not suitable for the system being supplied even a DC supply, wherein a battery may be presented for the system. Therefore, to overcome the challenge, a boost converter is used to increase the available DC voltage to the desired level. In this case, many sources and batteries can be the DC input for a boost converter, such as the rectified AC from a main electric supply, DC from dynamos, solar panels or fuel cells, and DC generators. Regarding the advantage of a boost in which this type of converter is able to supply large range of voltages, they will always be accompanied by a few regulations to control the output voltage. This results in the manufacturing of a lot of integrated circuits for this purpose. One of them is the LM27313, which is designed for the use in low power systems, such as cameras, mobile phones, and PDAs [10].

The circuit diagram of a boost converter with MOSFET and diode as a switching device is shown in Figure 2. The dc-to-dc boost converter consists of an inductor, MOSFET and diode as a switching device, and a capacitor and a resistor filter that are connected in parallel. When the MOSFET is at the on-state, the voltage at the diode will be inactive (off) and vice versa. The duty cycle at the diode depends on the duty cycle that is applied to the gate. The sum of both values will result in 100% duty cycle. The voltage at the diode must be doubled from the value of the voltage at the gate. On the other hand, the function of a capacitor in a rectifier circuit is to lessen the variation in the output voltage, letting it to behave like a dc [5].

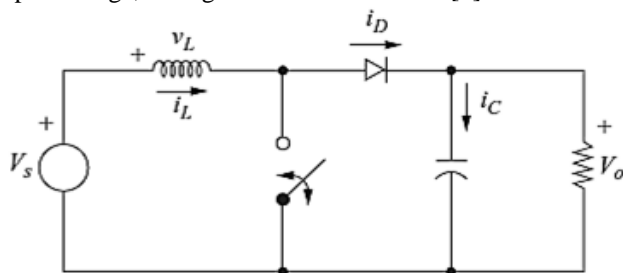

Figure 2: Basic circuit of a DC-to-DC Boost Converter [5]

Referring to [4], a 30 MHz resonant boost converter is able to be built by considering the combination of a Class Φ inverter with a class-E rectifier. This work uses a multistage resonant gate driver to power up the MOSFET effectively by providing high speed and low driving loss of a particular circuit. Besides, the equivalent impedance of the rectifier circuit can be stabilized as long as the output voltage remained constant. Thus, the effect of the load towards the ZVS operation can be minimalized.

In order to achieve better record for boost converter applications, [11] proposed a newer topology to have a high

gain non-isolated DC/DC boost converter. In this work, the converter topology is obtained using a single switch quadratic boost converter and a three-level boost converter. This type of converter has quadratic static gain as the function of a duty cycle. Then, the maximum voltage on both switches is limited to half of the output voltage, which is in balanced; hence, it is able to get rid of switches destruction and allow the connection of inverters with the capacitive voltage divider. An established work of [12] explained the enhancement of a boost converter whereby the converter is able to produce higher voltage conversion ratio than the traditional synchronously as a rectified boost converter does. The input and output inductor currents of a KY boost converter are continuous; therefore, it is suitable to be implemented in low-ripple applications.

Ripple current, on the other hand, has a great effect on the output condition of an electronic circuit. Therefore, the ripple current is reduced in an Interleaved Boost Converter by implementing advanced PWM techniques, as emphasized in [13]. The author presented a two-phase interleaved boost converter with a proportional integral controller, and simulated for various Pulse Width Modulation schemes. The results showed that the output voltage is well-monitored. This result indicate that this approach improves the efficiency of the system and able to reduce the ripple current.

As a boost converter is to step up the output voltage, [14] did a comparison between an Interleaved Boost Converter with a Conventional Boost Converter. In the paper, it is shown that a three-phase Interleaved Boost Converter gives a reduced ripple current as compared to the Conventional Boost Converter. By further comparative analysis, it is shown that the performance of an Interleaved Boost Converter can be enhanced by employing soft-switching and coupling inductors in the topology.

II. DESIGN METHODOLOGY

A. Class-E Rectifier

In this work, firstly, a design of a resonant low dv/dt Class-E Rectifiers has been developed. The specifications that need to be achieved are as shown in Table 1.

Table 1
Specifications to be achieved for Class-E Rectifier

Specification	Value
Output voltage, V_o	5V
Output current, I_o	0 to 0.1A
Operation frequency, f	1MHz
Output Voltage Ripple	< 5%

Furthermore, the ESR of the filter capacitor R_c is 25m Ω . The Class-E rectifier circuit is as shown in Figure 3.

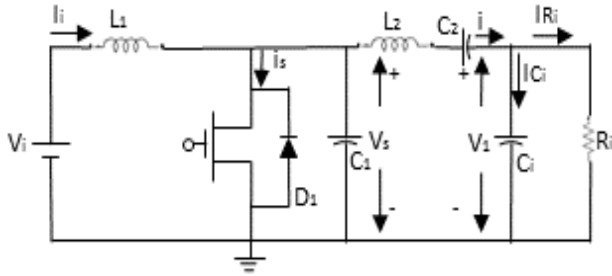

Figure 3: Circuit of a transformerless Class-E Rectifier [15]

Firstly, the minimum value of load resistance, R_{Lmin} was obtained by:

$$R_{Lmin}(\Omega) = \frac{V_o}{I_{O(max)}} \quad (1)$$

Then, the output power maximum, $P_{o(max)}$ and the value of inductor, L were calculated as follows:

$$P_{o(max)} = V_o I_{o(max)} \quad (2)$$

$$L = \frac{R_{Lmin}}{\omega_a Q} \quad (3)$$

For a resonant capacitor, C , current at diode, I_{dm} , the peak voltage value V_m , diode voltage, V_{dm} and the capacitor filter, C_f , were obtained using these formulas:

$$C = \frac{Q}{\omega_0 R_{Lmin}} \quad (4)$$

$$V_m = \frac{\sqrt{2}V_o}{M_{VR}}, \text{ where } M_{VR} = 0.3684 \quad (5)$$

$$I_{dm} = 2.777 I_{omax} \quad (6)$$

$$V_{dm} = 3.601 V_o \quad (7)$$

$$C_f = \frac{1}{\omega} \sqrt{\frac{1}{\left(\frac{V_r^2}{4(I_{dm} - I_o)^2}\right) - r_c^2}} \quad (8)$$

After all the values of the components were obtained, the simulation of the circuit was done in Multisim. The board was tested later on a breadboard and the components of the circuit were adjusted until the desired specifications were achieved. The readings and observations obtained were recorded as explained later in the Results section.

Figure 4 shows the circuit track which has been built using Proteus software.

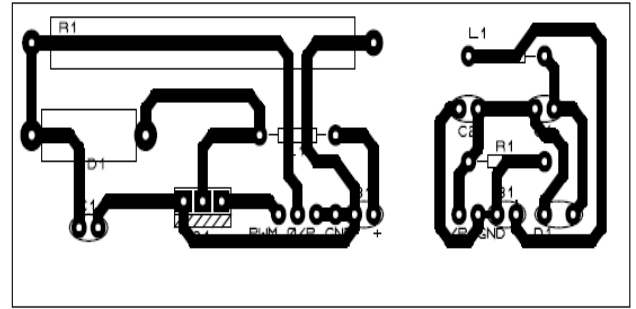

Figure 4: Circuit track of a Class E rectifier using Proteus software

Once the circuit testing process on a breadboard with the desired specifications was completed, the finalized circuit was then built on a printed circuit board (PCB). Figure 5 shows the final hardware specification built for the Class E rectifier and the Boost converter on a PCB.

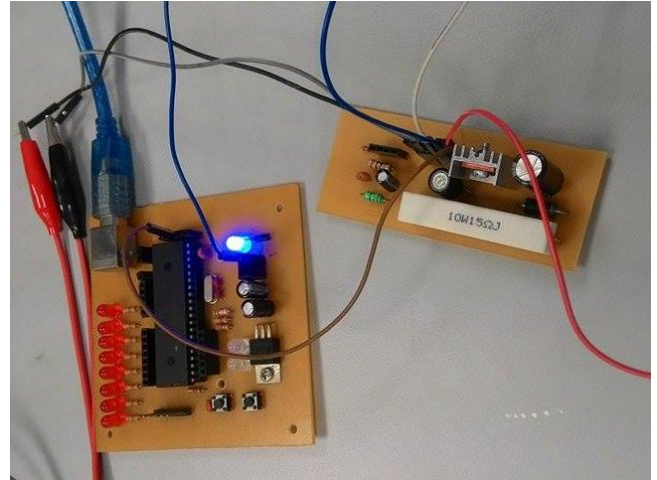

Figure 5: Class E rectifier and Boost converter on PCB

The detailed results will be discussed in following parts.

B. Boost Converter

The second part of the system consists of a boost converter designed to get a 12V output from a 5V source. The requirement for this design is the output voltage ripple, which must be less than 5% by controlling the capacitor.

Based on Figure 6, the duty cycle is calculated by using the following formula:

$$D = 1 - \frac{V_s}{V_o} \quad (9)$$

From the duty cycle, the value can now be calculated after the inductor used to form the continuous current operation is confirmed at the positive region. The formula to obtain the inductance value is as follows:

$$L_{min} = \frac{D(1-D)^2 R}{2f} \quad (10)$$

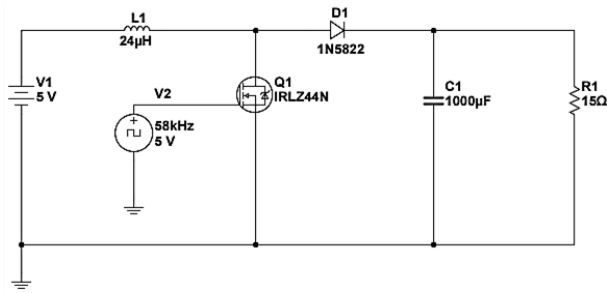

Figure 6: Circuit of a boost converter

Then, after the value of L_{min} was calculated, L was assumed to get the value of the inductor ripple current ΔI_L . The value of L has to be much larger than L_{min} to ensure the continuous-current operation. The variation in inductor current ΔI_L can be determined by this formula:

$$\Delta I_L = \frac{V_S D}{L f} \quad (11)$$

To find the values for the other parameters such as the inductor current, I_L , the following formula is used:

$$I_L = \frac{V_S}{(1 - D)^2 R} \quad (12)$$

After the inductor current has been calculated, the maximum and minimum inductor currents were also calculated using the average value. The change in current, $I_{L_{min}}$ is the minimum value of the current limit of the integrated switch, and $I_{L_{max}}$ is the maximum value of the current limit of the integrated switch [16]:

$$I_{L_{max}} = I_L + \frac{\Delta I_L}{2} \quad (13)$$

$$I_{L_{min}} = I_L - \frac{\Delta I_L}{2} \quad (14)$$

From the calculations, the suitable value of capacitance required by the limitation of the output ripple was obtained by using:

$$C = \frac{D}{R \left(\frac{\Delta V_o}{V_o} \right) f} \quad (15)$$

After all of the component values were obtained, a few steps were done ahead. Firstly, the simulation of the circuit was simulated using Multisim Software. Then, the experiment was conducted on a breadboard with the desired values of the components. Through observations, the desired results obtained were then recorded. After the experiment on a breadboard has succeeded with the targeted output values, the finalized circuit was done by Proteus simulation software and printed on a PCB board.

III. SIMULATION RESULTS

As mentioned earlier, this particular work is done using both software and hardware parts. Therefore, the simulation was conducted prior to the hardware to get an early picture of how the actual experimental works. Besides, the simulation results can be divided into two parts. The first part focuses on the Class E rectifier simulation and the second part is for the Boost Converter simulation. All of the component values used are obtained theoretically using the existing formulas for both parts.

A. Class E Rectifier

Based on the equations given in the design methodology section, the values obtained for the components are as tabulated in Table 2.

Figure 7 shows the complete Class-E rectifier simulation circuit whereby the values were obtained from theoretical formulas. Besides, the alternating current (AC) supplied to the circuit is 19.19Vp with the frequency of 1MHz.

Table 2
Calculated values for Class-E Rectifier

Parameter	Value
Resistance, R	50 Ω
Inductance, L	20.5µH
Capacitance, C	1.236nF
Peak value, V_m	19.19V
Diode current, I_{dm}	277mA
Diode voltage, V_{dm}	18V
Capacitor filter, C_f	251nF
Maximum power output, $P_{o_{max}}$	0.5W

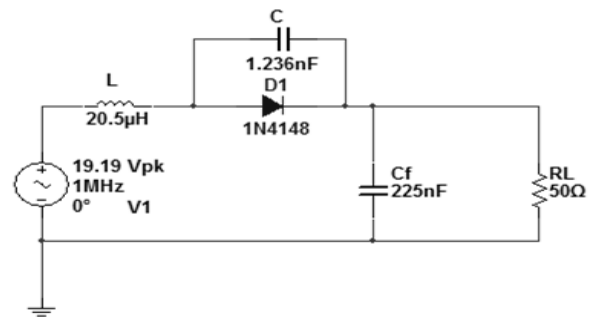

Figure 7: Simulation circuit of Class E circuit

Figure 8 shows the output voltage ripple for Class-E rectifier simulation captured by an oscilloscope.

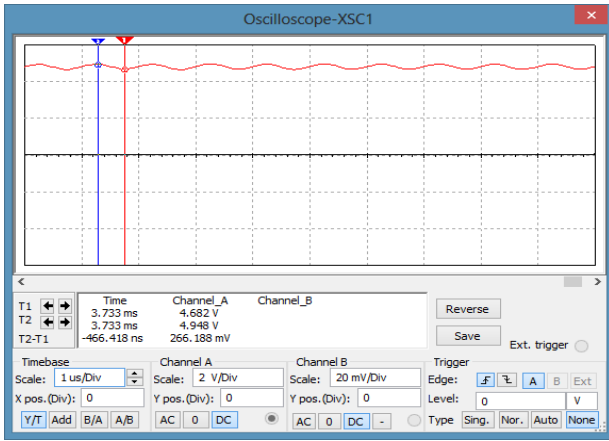

Figure 8: Output waveform of a Class E rectifier

Based on Figure 8, the output voltage ripple occurred at the waveform due to inadequate smoothing action by the calculated values for the capacitor. The values of output voltage ripple and the simulation results obtained for Class E- rectifier for each parameter are as presented in Table 3.

Table 3
Simulation Results for Class E Rectifier

Parameter	Value
Output Voltage, V_o	4.81V
Output Voltage Ripple, $\frac{\Delta V_o}{V_o}$	0.27V
Percentage of Output Voltage Ripple	5.61%
Output Current, I_o	0.10A
Output Power, P_o	0.48W

By comparison, the simulation results have a slight difference from the theoretically calculated values. As mentioned in Table 3, the percentage of output voltage ripple that is 5.61% is 0.61% higher than the calculated value (5%), and the output voltage, which is 4.81V is 0.19V lower than the preferred output voltage, 5V. Besides, the current produced for the simulation is low, indicating an insufficient power output for the simulated system.

B. Boost Converter

Based on the equations stated in the design methodology section for Boost Converter, the value obtained for the components involved in the circuit are as tabulated in Table 4.

Table 4
Calculated values for Boost Converter

Parameter	Value
Duty cycle, D	0.58
Resistance, R	15Ω
Minimum inductance, L_{min}	13.23μH
Variation in inductor current, ΔI_L	2.09A
Average inductor current, I_L	0.57A
Maximum inductor current, I_{Lmax}	1.84A
Maximum inductor current, I_{Lmin}	0.845A
Capacitance, C	2.32μF

As mentioned in the table, the minimum capacitance value is 2.32μF. However, the capacitance used in the experimental work is 1000μF. The capacitor value is able to contribute greatly towards the output voltage ripple, resulting in a better ripple smoothing.

With regard to the simulation part, the constructed boost converter built in Multisim is as shown in Figure 9. Diode 1N5822 has been selected because of its large current withstand, while MOSFET IRLZ44N is chosen due to its logic level MOSFET that can be triggered easily using PWM from the microcontroller board.

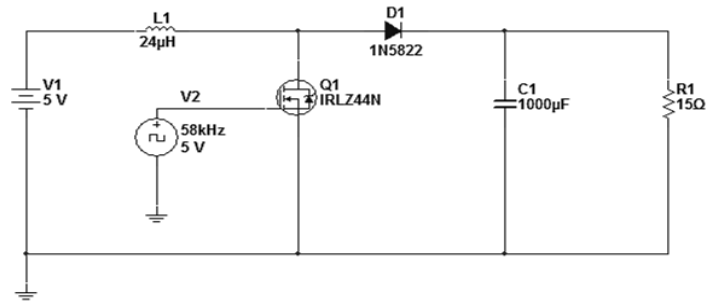

Figure 9: Simulation of a Boost Converter

Table 5 is the compilation of results obtained from the simulation of the Boost Converter. It is shown that the output voltage, V_o of the boost converter is 0.55V, which is lesser than the desired value 12V since the value is 11.45V.

Figure 10 shows the waveforms of the gate voltage, V_G in Channel A and drain voltage, V_{DS} in Channel B. From the observation, the amplitude value of V_{DS} is double as compared to V_G when the MOSFET is at the on-state and the diode is off, however, it has a contrast outcome during the pulse activation process. The duty cycle at the drain can be determined by acknowledging the remaining D value, which is 0.42.

Table 5
Simulation Results for Boost Converter

Parameter	Value
Input Voltage, V_s	5.00V
Output Voltage, V_o	11.45V
Output Current, I_o	0.74A
Voltage at gate, V_g	5.00V
Frequency, f	58kHz
Duty cycle, D	58%
Efficiency, η	85.00%
Output Power, P	8.7W

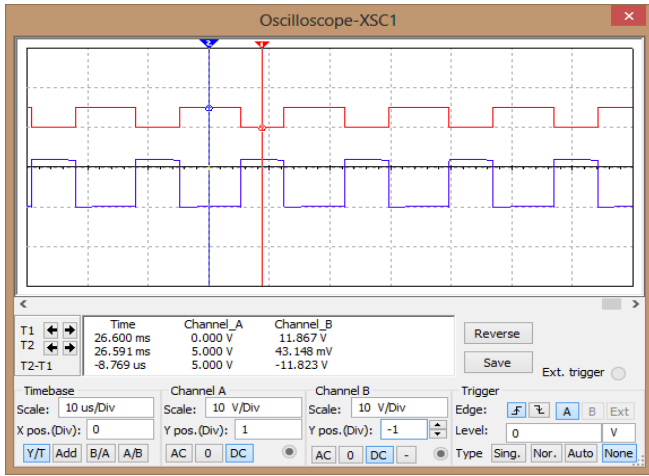

Figure 10: Waveform for V_G and V_{DS} of Boost Converter

As for the output value, which is the blue-coloured square waveform in Figure 10, the ripple is not too obvious as it is very small. Meanwhile, the output value of the waveform is the same as the observed value via multimeter in Multisim. In addition, the output power that has been obtained throughout the simulation is 8.7W. Thus, the simulation result is near to the targeted value with 1.3W difference.

IV. EXPERIMENTAL RESULTS

In this part, the experimental results are divided into two; the class-E rectifier and the boost converter.

A. Class-E Rectifier

The graph shown in Figure 11 is the input value that has been supplied to the Class-E rectifier. The requirement of the work, which is to achieve the frequency of 1MHz is satisfied. However, the maximum amplitude value achieved partial requirement because the value obtained is $11.3V_p$, whereby it is supposed to be equal to the voltage source, which is 19.19V.

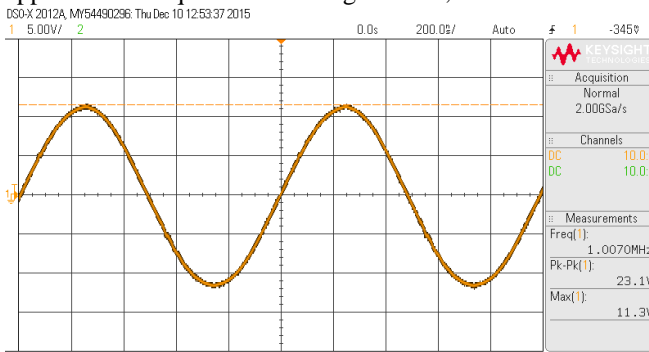

Figure 11: Simulation of Input for Class-E rectifier

The output voltage value, $V_o = 5.09V$ that has been obtained is as shown Figure 12, and its ripple value is 113mV (2.22%). Both of these outcomes have fulfilled the requirement of the work, in which the output voltage must be equal to 5V DC and the ripple formed is less than 5%.

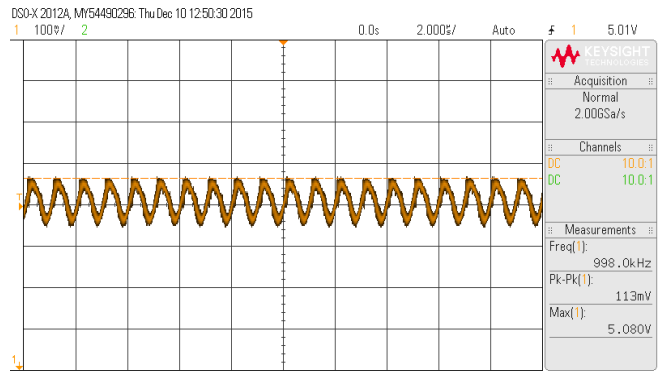

Figure 12: Simulation of output voltage for a Class-E rectifier

Table 5 presents a comparison between the simulation and the experimental results.

Table 5
Comparison between Simulation and Experimental Result

Parameter	Simulation	Experimental
Input Voltage, V_s	19.19V	11.30V
Output Voltage, V_o	4.81V	5.09V
Output Current, I_o	0.10A	0.02A
Ripple Voltage	0.27V	0.11V
Percentage of Ripple	5.61%	2.22%
Frequency, f	1 MHz	1MHz

The differences between these results are large because the values of the components used in the experiment depend on the standard values and they do not use the calculated values accurately.

B. Boost Converter

The source of DC-to-DC boost converter which has been supplied is as shown in Figure 13. The amplitude obtained is 6.3V, where it is much larger than the specification given. This is due to the harmonic distortion that appeared in this waveform.

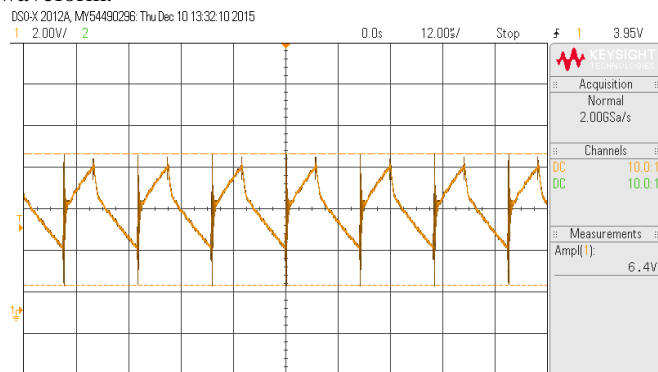

Figure 13: Simulation of input voltage for boost converter

From Figure 14, the waveforms between gate-to-source and drain-to-source are compared. When the gate-to-source waveform in source 2 is in ON state, the drain-to-source in source 1 will be in OFF state, and when the gate waveform is in OFF state, the drain waveform will be in ON state with the amplitude which is double from the amplitude in source 1. The

duty cycle in source 1 is equal to 59%, where it meets the boost converter concept that depends on voltage at sources and the output voltage, $D = 1 - \frac{V_s}{V_o}$. In contrast, the duty cycle at drain is 42%, and eventually when both duty cycles are added it will result in 100% duty cycle.

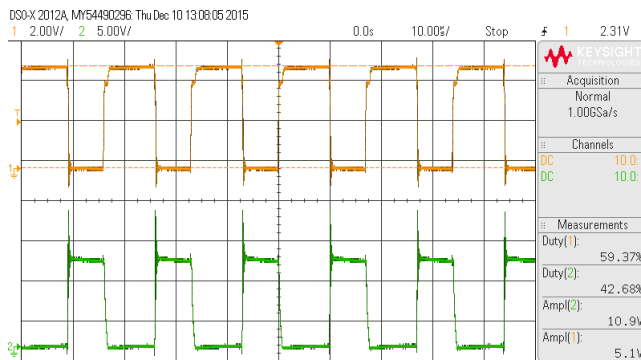

Figure 14: Waveform between gate-to-source and drain-to-source

Figure 15 shows the output voltage waveform of this work. The output voltage that has been obtained is 13.9V instead of 12V. There is the occurrence of gap between these voltages due to the harmonic distortion appeared in the waveforms.

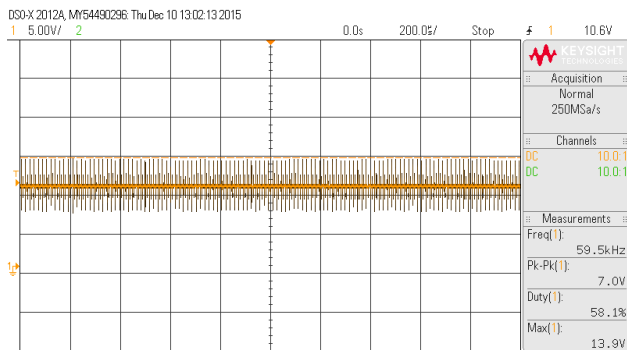

Figure 15: Output voltage waveform

A comparison between the experimental results and simulation results for dc-to-dc boost converter is shown in Table 6.

Table 6
Comparison between Simulation and Experimental Result

Parameter	Simulation	Experimental	
		Oscilloscope	Multimeter
Input Voltage, V_s	5.00 V	6.40 V	5.01 V
Output Voltage, V_o	11.45 V	10.90 V	10.50 V
Output Current, I_o	0.74 A	0.93 A	0.70 A
Voltage at gate, V_g	5.00V	5.10 V	5.00 V
Frequency, f	58kHz	59 kHz	59 kHz
Duty cycle, D	58 %	58.00 %	58.00 %
Efficiency, η	85.00 %	89.00 %	83.33 %

V. CONCLUSION

The design methodology and results of the integrated class-E rectifier circuit with a DC-to-DC boost power conversion has been presented in detailed in this paper. The controlled class-E rectifier with dc-dc boost converter is able to regulate the output voltage at fixed switching frequency by controlling the conduction angle or duty ratio of the MOSFET. The cycle time of the switch will determine the charging and discharging period for the capacitor. It is also shown that the simulation result of class-E rectifier has higher ripple percentage than the experimental results. For future works, there is a need to focus on the enhancement of the Class-E rectifier, such as including an impedance matching circuit to ensure a perfect connection between the Class-E rectifier and the boost converter. This is because the loss factors in the power transferring process cause a failure for the boost converter to behave as the expected perfect system.

REFERENCES

- [1] Marian K. Kazimierczuk and C. Dariusz, *Class E Zero Voltage Switching Resonant Inverter*. 2011.
- [2] a. Mediano and N. O. Sokal, "A Class-E RF Power Amplifier with a Flat-Top Transistor-Voltage Waveform," *IEEE Trans. Power Electron.*, vol. PP, no. 99, p. 1, 2013.
- [3] S. Lungu, A. Grama, D. Petreus, and A. Taut, "Simulation and design of a Class E power amplifier," *2009 32nd Int. Spring Semin. Electron. Technol.*, pp. 1–4, 2009.
- [4] W. Cai and Z. Zhang, "Analysis and design of a 30 MHz resonant boost converter," *Conf. Proc. - 2012 IEEE 7th Int. Power Electron. Motion Control Conf. - ECCE Asia, IPEMC 2012*, vol. 3, no. 51377077, pp. 1905–1909, 2012.
- [5] Daniel W.Hart, *Power Electronics*. 2011.
- [6] M. J. Grebennikov, Andrei and Sokal, Nathan O. and Franco, "Switchmode RF and Microwave Power Amplifiers, Second Edition," no. JULY 2012, pp. 1–82, 2012.
- [7] M. K. Kazimierczuk and J. Jozwik, "Resonant DC/DC converter with class-E inverter and class-E/rectifier," *IEEE Trans. Ind. Electron.*, vol. 36, no. 4, pp. 568–578, 1989.
- [8] B. Andreyca, "Zero voltage switching resonant power conversion," *UNITRODE Power Supply Des. Semin. SEM- ...*, 1990.
- [9] J. Song, a. Greenwood, and I. Batarseh, "Analysis and design of zero-voltage-switching class-E converter," *Proc. SOUTHEASTCON '96*, pp. 545–550, 1996.
- [10] S. Mode, P. Supplies, and S. M. Designs, "Power supplies," pp. 1–20, 2013.
- [11] J. B. R. Cabral, T. Lemes da Silva, S. V. G. Oliveira, and Y. R. de Novaes, "A New High Gain Non-Isolated DC-DC Boost Converter for Photovoltaic Application," *2013 Brazilian Power Electron. Conf.*, pp. 569–574, 2013.
- [12] K. I. Hwu and Y. T. Yau, "A KY boost converter," *IEEE Trans. Power Electron.*, vol. 25, no. 11, pp. 2699–2703, 2010.
- [13] A. Electronics, "Ripple Current Reduction in Interleaved Boost Converter by Using Advanced PWM Techniques 2," no. 978, pp. 115–119, 2014.
- [14] D. J. S. Newlin, R. Ramalakshmi, and S. Rajasekaran, "A performance comparison of interleaved boost converter and conventional boost converter for renewable energy application," *2013 Int. Conf. Green High Perform. Comput.*, no. Ccm, pp. 1–6, 2013.
- [15] Marian K. Kazimierczuk and C. Dariusz, *Class E Zero Voltage Switching Resonant Inverter*. 2011.
- [16] B. Hauke, "Basic Calculation of a Buck Converter 's Power Stage," no. December 2011, pp. 1–8, 2012.