

Evaluation of Interfaced Plate Parameters on Impact-Based Piezoelectric Power Generation

N. X. Yan¹, A. A. Basari¹, K. S. Leong¹, N. A. A. Nawir¹ and S. Hashimoto²

¹Faculty of Electronic and Computer Engineering, Universiti Teknikal Malaysia Melaka, Durian Tunggal, 76100 Melaka, Malaysia.

²Division of Electronics and Informatics, School of Science and Technology, Gunma University, Kiryu-shi, Gunma, Japan. amat@utem.edu.my

Abstract— Generally, the piezoelectric will be hit directly for the impact-based piezoelectric energy harvesters to obtain the output voltage and power. A different approach is utilized to demonstrate and evaluate the effect of the interfaced plate on the impact-mode piezoelectric energy harvesting system in this paper. The purpose of this study is to characterize the influence of the interfaced plate on the output efficiency of such a harvester to enhance its performance. The concept is based on the energy absorbed by the interfaced plate after impacted by a ball and spread the energy equally on the piezoelectric disc to harvest electrical charges. Besides that, the penetrated depth of the piezoelectric disc which is caused by the interfaced plate, will stretch the piezoelectric and yield electrical charges. The interfaced plate is attached on top of the piezoelectric disc. A free fall experiment has been conducted to evaluate the performance of the piezoelectric by changing the force with a different value of ball mass and height dropped. There are two parameters of the interfaced plate that will be investigated: diameter of the interfaced plate and height of the interfaced plate. When the diameter of the interfaced plate is decreased, the amplitude of the output power of the piezoelectric disc is expected to be increased. While when the height of the interfaced plate is decreased, the amplitude of the output power of the piezoelectric disc is expected to be increased. These statements have been proven and validated in this paper. However, for the instantaneous impact force (free fall experiment), the output power of the piezoelectric disc without an interfaced plate is higher than the output power of the piezoelectric disc that attaches to the interfaced plate.

Index Terms— Energy harvester; Piezoelectric disc; impact-based; free fall; Interfaced plate.

I. INTRODUCTION

Recently, the need for energy harvesting is growing for the advances in portable devices of the electronic application, i.e., wireless sensor [1]. Energy harvesting is known as capturing the ambient waste energy, collecting them and storing the energy for later use. Energy harvesting is also defined as power harvesting or energy scavenging [1]–[3]. There are various types of energy sources, i.e., thermal sources, mechanical sources, ambient light, ambient radio frequency and vibrational energy [1][2]. Energy harvesting is desired for the portable devices because they are self-powered and the limited life-span of the battery [3].

For the vibrational energy harvesting, there are some techniques to transform the mechanical energy into electricity: electromagnetic induction, electrostatic storage, and a piezoelectric transducer. The piezoelectric transducers can provide higher energy efficiency and flexible compared

to the electrostatic and electromagnetic techniques. This is because of the piezoelectric transducer can convert the applied forced or mechanical vibrations into electricity with a simple configuration [1].

The pressure electricity can be represented by piezoelectricity. The crystal of the piezoelectric elements, i.e., barium titanate, quartz, Rochelle salt, etc. can generate electricity during the pressure or force is applied. This deformation is termed as a direct effect, and it can be used as a sensor. While the crystal of the piezoelectric converts into mechanical strain energy when an electric field is applied, this deformation is known as a converse effect. The converse effect can be used as an actuator. Both behaviors can be modeled by equation (1) and equation (2) below:

Direct piezoelectric effect:

$$D_i = e_{ij}^c E_j + d_{im}^d \sigma_m \quad (1)$$

Converse piezoelectric effect:

$$\varepsilon_k = d_{jk}^c E_j + S_{km}^E \sigma_m \quad (2)$$

where vector D_i is referred to the dielectric displacement, ε_k is the strain vector, vector E_j is represented the applied electric field and σ_m is stress vector. The piezoelectric coefficients which are d_{im}^d and d_{jk}^c are piezoelectric constants. The e_{ij}^c vector is dielectric permittivity and S_{km}^E vector is the elastic compliance matrix. The converse effect and direct effect are symbolled as c and d, respectively. While the quantity which is measured at constant stress and constant electric field are represented by σ and E , respectively [1].

There are some energy harvesting devices required impulsive loading to yield electrical energy for some application. The impulsive loading such as short duration acceleration or deceleration shock loading like an explosion, the impact of an object with the host system or vice versa, etc. The impact system may have a single pulse or multiple pulses. The characteristics and related motions of the instantaneous impact energy harvesting device are sort duration and generate a high output amplitude. The impact-based energy harvesting device is needed to have a capability that can endure the physical damage, capture the yielded electricity on that short duration efficiency, transmit the mechanical energy to energy harvesting device efficiency,

etc.

There are two groups for the impact-based energy harvesting devices. The short-duration loading for the impact is applied directly to the piezoelectric transducer to harvest electrical energy is known as the first group for the impact-based energy harvesting devices. The pulse duration is a very small less from a millisecond. Therefore, it is a challenge to collect and store the electrical energy efficiency. While the second group, the devices are used an interfaced mechanism to transmit impact force or mechanical energy to a mechanical energy storage device. The stored mechanical energy is transformed into electrical energy through a designed transducer such as piezoelectric. The interfaced mechanisms such as spring or plate can be used. The impact force is stored in the spring as mechanical potential energy when it is in the rest position and/or as mechanical kinetic energy when it is in vibration condition. Then, the mechanical vibration energy is transferred to the piezoelectric and transformed into electrical energy with the aid of the piezoelectric elements [4].

There are various types of methods to enhance the performance of the impact-based piezoelectric energy harvesting system have been investigated. The methods are: by using cantilever piezoelectric [5][6], impact-based frequency-up-converting method [7][8], free fall experiment [9]–[12], by using interfaced plate between hitting object and piezoelectric transducer [13][14], free moving object [15]–[20], human step [21]–[23], and impact of the rotating gear on the piezoelectric transducer [24][25]. All these approaches are used to increase the amplitude of the output power of the piezoelectric transducer. [5] proved that the impact-based piezoelectric cantilever could generate 20 times higher output voltage compared to vibration and bending techniques. The using interfaced plate between the hitting object and piezoelectric transducer method was used by [13][14]. The authors prove that by using the interfaced plate, the performance and output efficiency of the impact-based piezoelectric energy harvesting system is enhanced about 4.3 times compared to direct hitting on the piezoelectric transducer. However, the lack of information about the characteristics of the parameters for the impact-based piezoelectric energy harvesting device is discussed.

Therefore, this paper demonstrates a novel concept of the parameters of the interfaced plate that can affect the performance of the piezoelectric disc. In a different approach, which is indirectly hitting on the piezoelectric energy harvester through an interfaced plate is used in this study. The energy absorbed by the interfaced plate is then spread equally on the piezoelectric disc, and the penetrated depth caused by the interfaced plate to harvest electric charges are the concepts of this study to be investigated. A method of combining the free fall experiment and using the interfaced plate methods is described in this paper. The main objective of this study is to investigate and characterize the effect of the interfaced plate on the output efficiency of the piezoelectric disc. There are five parameters that affect the output power of the piezoelectric disc with the interfaced plate will be evaluated and analyzed. The parameters are load resistance, the diameter of the interfaced plate, the height of the interfaced plate, ball mass and height of the ball dropped. The free fall experiment method is utilized to investigate the

relationship of the parameters to the output power of the piezoelectric disc. This is because of the free fall involves the gravity. Gravity is the only force acting upon the motion of an object, and the air resistance will be ignored. The investigation of the parameters can be used to study the impact-mode piezoelectric energy harvesting system for future work.

II. ENERGY ABSORBED BY THE INTERFACED MECHANISM OF THE ENERGY HARVESTING BASED ON IMPACT FORCE OF OBJECT IN FREE FALL

Mechanical energy is determined as energy attained by the work is done upon the objects. There are two types of mechanical energy: kinetic energy and potential energy. During a free fall experiment, the maximum potential energy is formed when an object is at the highest position. Then, the potential energy will change to kinetic energy when the object is dropped and hit on the ground. Thus, the behavior can be modeled as equation (3) below.

$$mgh_1 = \frac{1}{2}mv^2 \quad (3)$$

where vector m is referred to the object's mass, g is the gravity's acceleration vector, h_1 is represented to the height vector, and vector v is the velocity. When the height, h_1 is known, the velocity can be found by using the equation $v = \sqrt{2gh_1}$. When the ground is softer than the object dropped, the object will penetrate the ground. The impact force for free fall object is depended on the impact depth, h_2 of the ground when it is in damping condition. It can be modeled as equation (4).

$$F = \frac{E_k}{h_2} = \frac{mv^2}{2h_2} \quad (4)$$

where E_k vector is kinetic energy. The equation (4) shows that the impact force is inversely proportional to the impact depth, h_2 . It also shows that the impact force is directly proportional to the mass of an object and velocity factors. When the ground is harder than the object dropped, the object will be bounced back several times after hitting to the ground. This condition will be continued until the momentum of the object becomes zero and it is known as damping condition. The impact force can be expressed in equation (5).

$$F = \frac{dp}{dt} \quad (5)$$

Thus, it shows that the output power of the piezoelectric energy harvester depends on the impact velocity of the object as well as the impact force of an object when the object's kinetic energy and momentum are constant.

Based on the law of conservation of energy, it states that energy cannot be created nor destroyed. It only can be changed into another formed of wasted energy such as heat in overcoming friction [26]–[28]. Thus, the kinetic energy of an object dropped will be absorbed by the interfaced mechanism when the object is impacted on the interfaced mechanism. Then, the interfaced mechanism will transfer the energy to the

piezoelectric transducer.

There is an impact force due to the object with certain mass, m is dropped from a certain height, h_1 . When the object hits on the interfaced mechanism, an amount of deformation of an interfaced mechanism, u will be decreased until all the kinetic energy of the object is absorbed in the interfaced mechanism. When the mass of the object dropped, m is known, the strain required by the interfaced mechanism to absorb the energy will be determined. The amount of deformation of an interfaced mechanism, u will be defined by the elastic deformation of the interfaced mechanism. When the mass of the object dropped hits on the interfaced mechanism, the deformation of the energy will occur depending on the stiffness of the interfaced mechanism. The interfaced mechanism is assumed as a spring, the amount of the energy absorption and the force can be modeled as below.

$$F = K \times u \quad (6)$$

where vector K is the stiffness of the spring. Then, the equation (6) is divided by the cross-sectional area, A and becomes $\frac{F}{A} = \frac{K}{A} \times u$. Due to the deflection of the interfaced mechanism that is affected by the impact force, F , so the $u = \varepsilon L$. The object is dropped through a total fall height equals to $h_1 + u$. Thus, the energy absorbed would become $W = mg(h_1 + \varepsilon L)$.

The deformation of the interfaced mechanism will result in energy absorbed until the elastic of the interfaced mechanism reaches to its limitation. As the $\frac{F}{A}$, σ is referred to stress, the energy absorbed of the elastic interfaced mechanism can be expressed as $W_{elastic} = \frac{1}{2} \frac{F}{A} \varepsilon AL$. Then, the equation can be expressed as below when $W = W_{elastic}$.

$$mg(h_1 + \varepsilon L) = \frac{1}{2} \frac{F}{A} \varepsilon AL \quad (7)$$

Lastly, it will be simplified and modeled as equation (7) below.

$$F = 2mg \left(\frac{h_1}{\varepsilon L} + 1 \right) \quad (8)$$

Thus, it shows that the impact force is directly proportional to the object mass and drops height factors. The higher the object mass value, the larger the impact force, as well as the drop height factor. However, the amount of the deformation of an interfaced mechanism, u or εL is inversely proportional to the impact force. As the smaller, the amount of deformation will result in a larger the impact force.

III. METHODS AND MATERIALS

For the free fall experiment, a setting base for the piezoelectric ceramic disc is designed as shown in Figure 1. There is a size of the hole that can support the piezoelectric transducer to stretch in maximum position when there is a force applied to the piezoelectric transducer. Thus, it can improve and maximize the generated output power from an impact force. The dimension of the setting base is $(140 \times 50 \times 5)mm^3$ and the diameter of the hole is 30mm.

As mention in the Introduction section, a free fall test was conducted to evaluate the performance of the piezoelectric transducer with the interfaced mechanism. The performance of the piezoelectric transducer will be in term of the output voltage and output power that is generated by an impact force. The interfaced mechanism is known as an interfaced plate. The aluminum interfaced plates are designed in terms of different diameters and different heights which is illustrated in Figure 2. The diameters of the interfaced plates are 4mm, 6mm, 8mm, 10mm, 12mm, and 14mm. While the heights for each diameter of the interfaced plates are 1mm, 3mm, 5mm, 7mm, and 9mm.

The type of piezoelectric transducer that is used for this free fall experiment is piezoelectric ceramic disc. This external drive type of piezoelectric disc is 7BB-35-3L0 which is manufactured by Murata Manufacturing Co., Ltd. The piezoelectric transducer is shown in Figure 3. The specifications of the piezoelectric ceramic disc are illustrated in Table 1.

The experiment setup for the free fall test is demonstrated in Figure 4. Different values of impact force are applied on the piezoelectric ceramic disc by changing the value of object's mass, and the height of the object dropped. A guiding tube is used to lead the object can be dropped accurately on top of the piezoelectric disc. A resistor is a connected parallel to the output of the piezoelectric disc. The decade resistance box, manufactured by Crotech UK is utilized as a load resistor. The instantaneous harvested output power is measured by using digital storage oscilloscope which is manufactured by Mega Zoom. The experiments equipment and materials used for the free fall test is illustrated in Figure 5.

This experiment is conducted 15 times for each parameter and variables. A total of 15 output reading of the piezoelectric disc is taken, and the average is calculated as a result. This is because of the impact force cannot be controlled perfectly as the steel ball might not drop accurately on the center of the piezoelectric disc. Besides that, the piezoelectric disc is needed to be in perfect condition. If the piezoelectric disc electrode is cracked or peeled off, the output voltage and power of the piezoelectric disc will be affected and decreased as the tightness of the stretch of the piezoelectric disc will be decreased.

IV. EXPERIMENTAL RESULTS AND DISCUSSIONS

The experiment configuration is illustrated in Figure 4 and 5. The input variables for the free fall test are resistance value, object's mass, the height of the object dropped, the diameter of the interfaced plate and height of the interfaced plate. A steel ball is used as an object dropped. The masses of the steel ball are 3g, 5g, 7g, 9g, 11g, 14g and 16g. The heights of the steel ball dropped are 30mm, 40mm, 50mm, 60mm, 70mm, 80mm, 90mm, and 100m. The output of the piezoelectric disc is connected to a load resistor. The output reading is measured and recorded by using an oscilloscope. The sampling time of the output reading is in 100ms.

In order to harvest an optimum output power for the piezoelectric disc with and without interfaced plate, an experiment is conducted to evaluate an optimum resistor value of the piezoelectric. The output voltage and output

power are measured with the range of the resistor value from 20Ω to $1M\Omega$. The height of the steel ball dropped is 70mm, and the steel ball mass is 5g. An interfaced plate is allocated

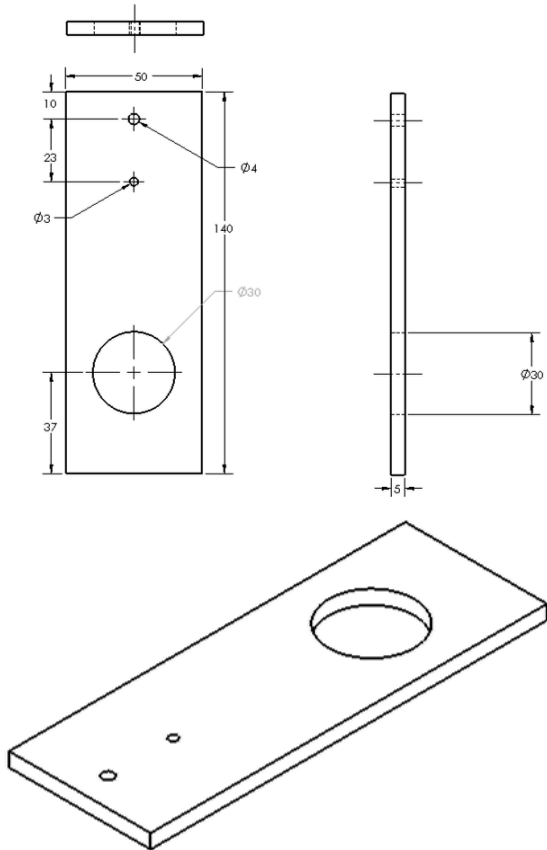

Figure 1: Dimension of the setting base structure.

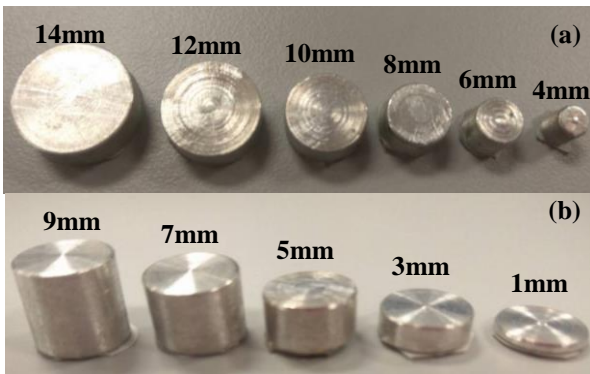

Figure 2: The structure design of interfaced plate (a) Different diameter of the interfaced plate (b) Different height of the interfaced plate



Figure 3: The piezoelectric disc, manufactured by Murata Manufacturing Co.

between the steel ball and the piezoelectric disc to determine the optimal load resistance of the piezoelectric disc with the interfaced plate. The diameter of the interfaced plate is 4mm, and the height of the interfaced plate is 5mm. Figure 6 and 7 plot the comparison of the output efficiency of the piezoelectric disc between with and without interfaced plate versus voltage and power respectively to obtain the optimal

load resistance. Figure 6 shows that the higher the load resistance, the higher the output voltage until a certain value of the load resistor. For the piezoelectric disc without

Table 1
Specifications of the Piezoelectric ceramic disc

Parameter	Value
Plate size diameter (mm)	35
Element size diameter (mm)	25
Electrode size diameter (mm)	23
Thickness (mm)	0.53
Plate thickness (mm)	0.30
Resonant Impedance (Ω)	200
Capacitance (nF)	$30.0 \pm 30\%$ (1kHz)
Plate material	Brass with lead wire

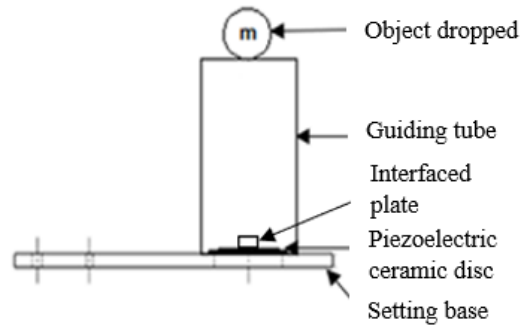

Figure 4: Experiment setup for Free Fall Test.

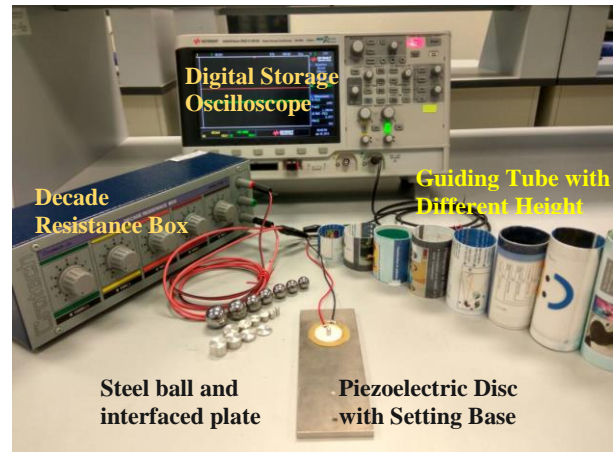

Figure 5: Equipment and materials for the free fall test.

interfaced plate, when the load resistor value is $200k\Omega$, the output voltage is started in saturation condition as the value of the load resistor is increased. While the piezoelectric disc with an interfaced plate, when the load resistor value is $10k\Omega$, the output voltage is started in saturation condition. The figure illustrates that the output voltage of the piezoelectric disc with the interfaced plate is lower than the without an interfaced plate.

The maximum output power can be harvested when the value of load resistance is $10k\Omega$ for both piezoelectric disc with and without an interfaced plate is shown in Figure 7. The harvested maximum output power of piezoelectric disc without an interfaced plate is higher than the with an interfaced plate which is 672mW and 550mW respectively.

From these figures show that the output voltage and output power value are smaller when the interfaced plate is allocated between the steel ball dropped and piezoelectric disc compared to the without an interfaced plate. This is believed

that it is because of the impact force of the free fall experiment does not have any frequency or continuous frequency like the papers in [13][14]. As the impact energy can be found out from the equation of $E_{imp} = E_{el} + E_{abs}$, where E_{imp} is

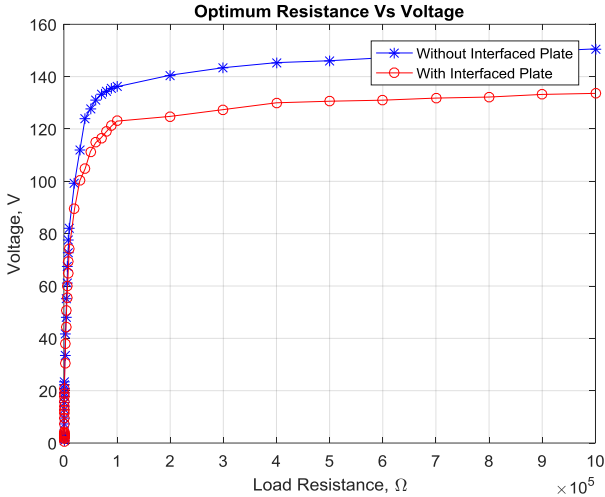

Figure 6: Maximum output voltage of piezoelectric disc versus different value of load resistance.

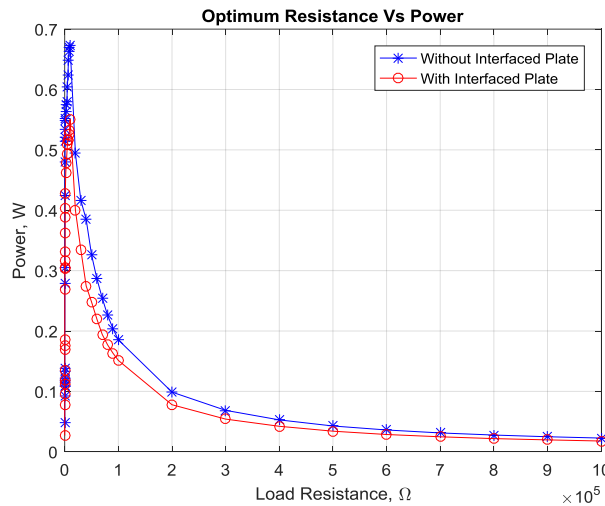

Figure 7: Maximum output power of piezoelectric disc versus different load resistance value.

represented as impact energy, E_{el} is referred to energy stored in the elastic strain energy of the piezoelectric disc, and E_{abs} is the energy absorbed. For this paper which is an interfaced plate is attached to the piezoelectric disc, the E_{absip} is referred to the energy absorbed by the interfaced plate. The impact force of the free fall experiment only occurs instantaneous impact on the piezoelectric disc; the steel ball will be bouncing back until the steel ball momentum become zero. A damping condition will occur. Therefore, at the same time, the energy absorbed by the interfaced plate also will be drained. Thus, the first impact of the instantaneous impact energy of the free fall experiment for the piezoelectric disc is calculated as $E_{imp} = E_{el} + E_{absip}$, where $E_{absip} < 1$. Consequently, the output efficiency of the piezoelectric disc with the interfaced plate is lower than the piezoelectric disc without an interfaced plate. Due to the energy impact of the piezoelectric disc without an interfaced plate is calculated as $E_{imp} = E_{el} + E_{abs}$.

However, [13][14] can harvest higher output efficiency when attached the interfaced plate on the piezoelectric compared to the without interfaced plate piezoelectric disc. This is believed that the continuous frequency is created by using the shaker in [13][14] can calculate the impact energy as $E_{imp} = E_{el} + E_{absip1} + E_{absip2}$. Where the E_{absip1} is referred to the energy absorbed by the interfaced plate at

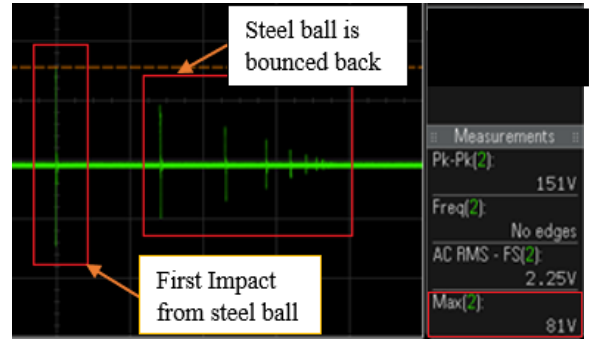

Figure 8: Maximum output voltage of piezoelectric disc without the interfaced plate when impact force is applied.

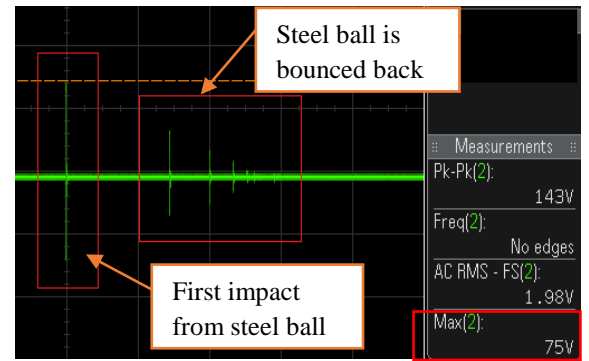

Figure 9: Maximum output voltage of piezoelectric disc with the interfaced plate when impact force is applied.

impact of the first cycle frequency and E_{absip2} is referred to the energy absorbed by the interfaced plate at the impact of the second cycle frequency. The higher value of the frequency, the shorter the time deviation of the impact-mode of the piezoelectric disc. The energy absorbed by the interfaced plate is equal to $E_{absip1} + E_{absip2}$. This is because of the E_{absip1} is not totally lost from the interfaced plate when the second cycle of frequency impact on the piezoelectric disc. So, the output efficiency of the piezoelectric disc with the interfaced plate is higher than the piezoelectric disc without an interfaced plate. As the impact energy of the interfaced plate is attached on the piezoelectric disc is higher compared to the without an interfaced plate.

From Figure 7 shows that the 10kΩ of load resistance should be chosen to be utilized for the optimal load resistance as it can achieve and generate the highest output power of the piezoelectric disc.

Figure 8 illustrated an instantaneous output voltage from an impact force by a steel ball. The output of the piezoelectric disc is interfaced to the 10kΩ of the load resistor. The steel ball mass is 5g, and the height of the steel ball dropped is 70mm. This figure shows that the steel ball impacted on the piezoelectric disc for the first time with the highest momentum of the steel ball. Thus, the first impact generated the highest output voltage which is 81V_{max}. After that, the steel ball is bounced until the momentum becomes zero. Hence, the damping condition occurs as the output voltage is decreased to zero.

While, Figure 9 demonstrated an instantaneous output voltage of the piezoelectric disc with an interfaced plate from an impact force. This figure shows that the output voltage is $75V_{max}$ when the steel ball is impacted on the interfaced plate that allocated on top of the piezoelectric disc.

After that, the free fall experiment is carried on by allocating the interfaced plate between the steel ball dropped and the piezoelectric disc. The diameters of the interfaced

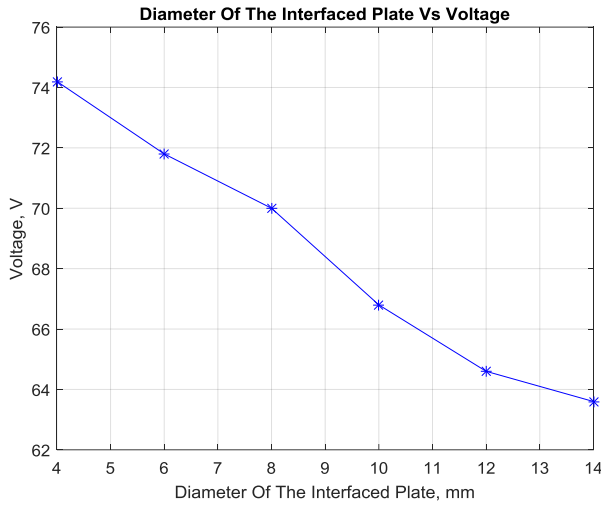

Figure 10: Output voltage of the piezoelectric disc with different value of diameter of the interfaced plate.

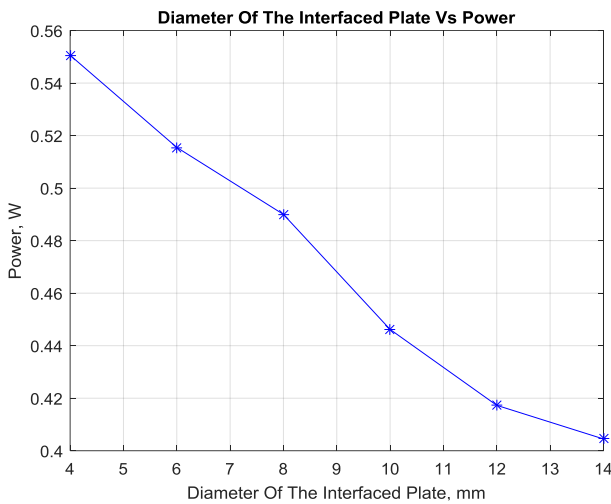

Figure 11: Output power of the piezoelectric disc with different value of diameter of the interfaced plate.

plates are 4mm, 6mm, 8mm, 10mm, 12mm, and 14mm. The interfaced plate height is fixed at 5mm. The steel ball mass of 5g is used and dropped at the height of 70mm. The piezoelectric disc is interfaced with the 10kΩ of load resistance. Then, the output voltage is being measured and recorded from the digital storage oscilloscope. Figure 10 and 11 plotted the graph of the output voltage and power versus the diameter of the interfaced plate. Figure 10 shows that the output voltage is inversely proportional to the diameter of the interfaced plate. The larger the diameter of the interfaced plate, the lower the output voltage. This is because of the smaller the diameter of the interfaced plate, the smaller the area of the interfaced plate. Thus, it will increase the indentation depth of the piezoelectric disc. Therefore, the piezoelectric disc will be stretched down tightly then generate a higher output voltage of the piezoelectric disc. However, the output voltage of the piezoelectric disc without interfaced

plate which is 81V is larger than the 74.2V of the output voltage of the piezoelectric disc with the interfaced plate. This is because of the impact energy of the piezoelectric disc with an interfaced plate for free fall experiment is lower than the impact energy of the piezoelectric disc without an interfaced plate. The explanation of the impact energy for free fall experiment is mention as before.

Besides that, Figure 11 also shows that the output power is decreased when the diameter of the interfaced plate is

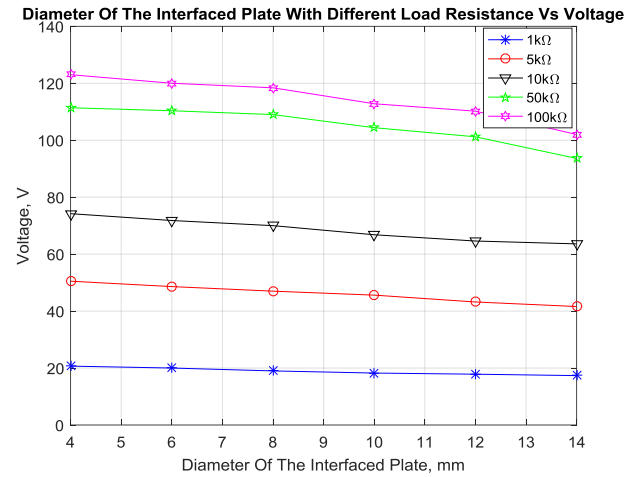

Figure 12: Output voltage of the piezoelectric disc with different value of diameter of the interfaced plate.

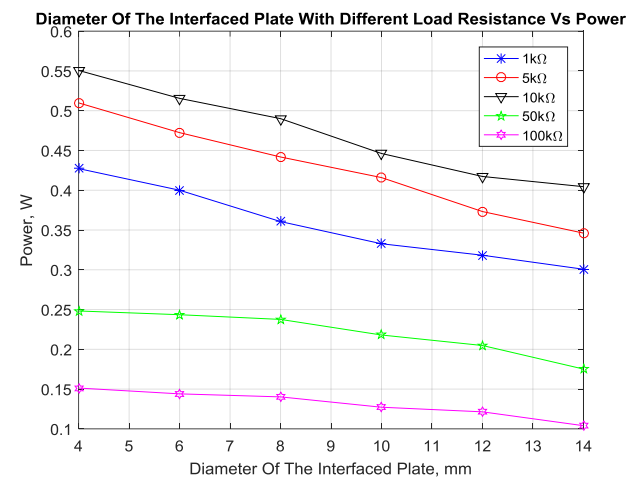

Figure 13: Output power of the piezoelectric disc with different value of diameter of the interfaced plate.

increased. As the $P = VI$, which the power is directly proportional to the voltage. Thus, when the voltage is inversely proportional to the diameter of the interfaced plate, theoretically the power will be also inversely proportional to the diameter of the interfaced plate. The output power of the piezoelectric disc without and interfaced plate is 672mW which is higher compared to the 551mW of the output power of the piezoelectric disc with the interfaced plate.

Next, this free fall experiment is repeated by changing the value of the load resistance. The load resistance values are 1kΩ, 5kΩ, 10kΩ, 50kΩ and 100kΩ. The 5g of steel ball mass is used and dropped at 70mm height. The diameters of the interfaced plate are 4mm, 6mm, 8mm, 10mm, 12mm, and 14mm. The interfaced plate height is 5mm. Figure 12 shows the graph of the output voltage and the diameter of the interfaced plate with a different value of the load resistance. Same as previous, the larger the value of the interfaced plate diameter will decrease the value of the output voltage. From

the figure, the highest output voltage is harvested by connecting 100kΩ of load resistance then followed by the 50kΩ, 10kΩ and 5kΩ of load resistances. The lowest output voltage is harvested by connecting 1kΩ of load resistance. Due to the $V = IR$, which voltage is directly proportional to the resistor. Therefore, when the load resistance is increased, the output voltage should be increased as well.

The plotted graph of the diameter of the interfaced plate versus power with a different value of load resistance is illustrated in Figure 13. The output power is decreased as the

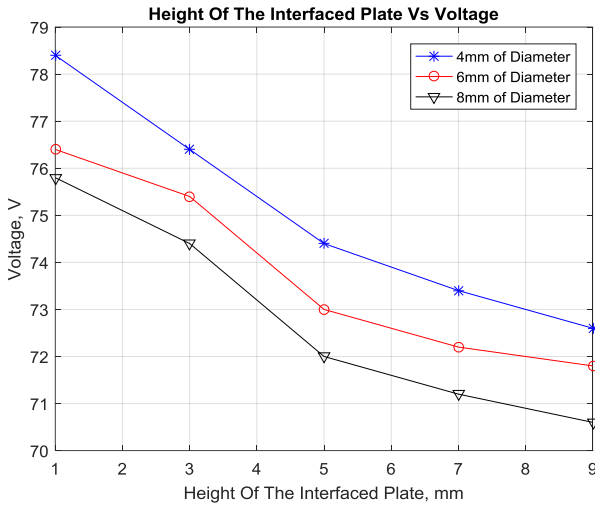

Figure 14: Output voltage of the piezoelectric disc with different value of height of the interfaced plate.

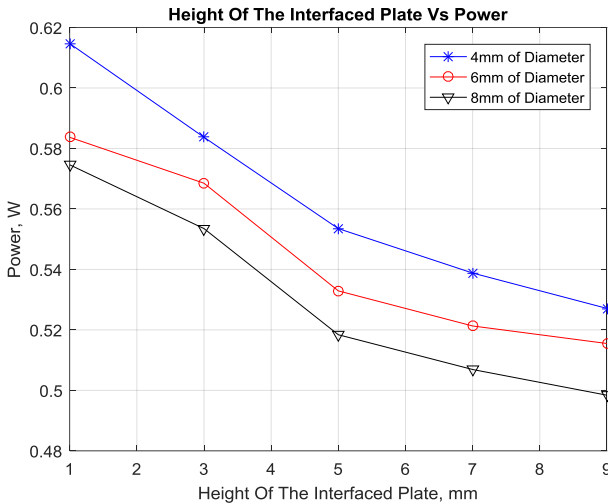

Figure 15: Output power of the piezoelectric disc with different value of height of the interfaced plate.

diameter of the interfaced plate is increased. With the 10kΩ of load resistance, the highest output power can be harvested, then followed by the 5kΩ, 1kΩ and 50kΩ of load resistance. The lowest output power is yielded when the 100kΩ of resistance is connected. When 10kΩ of load resistance is connected to the piezoelectric disc, the current of the piezoelectric disc that has been measured is the highest current range. Thus, the piezoelectric disc that is interfaced to the 10kΩ of load resistance can achieve the highest value of output power. This figure shows that with the 10kΩ, 5kΩ and 1kΩ, the output power is decreased dramatically as the diameter of the interfaced plate is increased. While with the 50kΩ and 100kΩ, the output power is slightly decreased as the diameter of the interfaced plate is increased.

The free fall experiment is proceeded to analyze about the effect of the height of the interfaced plate to the performance of the piezoelectric disc. The interfaced plate heights are 1mm, 3mm, 5mm, 7mm, and 9mm. The 4mm, 6mm and 8mm of the diameter of the interfaced plate are used. While the steel ball mass is 5g, the height of the steel ball dropped is fixed at 70mm, and the piezoelectric disc is interfaced to the 10kΩ of load resistance. The output voltage versus height of the interfaced plate for a piezoelectric disc with varying the diameter of the interfaced plate is shown in Figure 14. The result shows that the smaller the value of the height of interfaced plate, the higher the output voltage is produced.

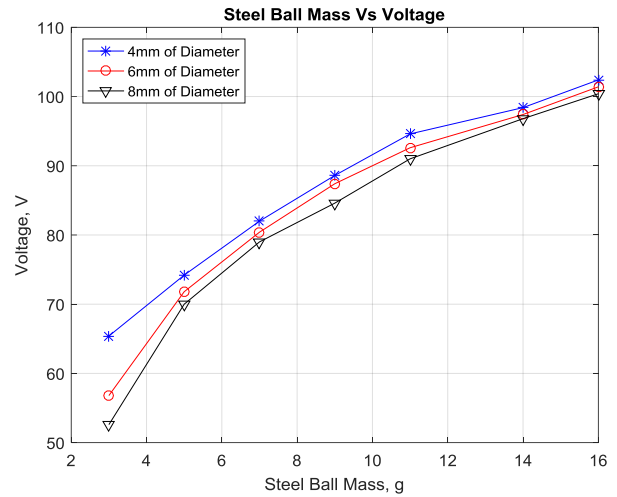

Figure 16: Output voltage of the piezoelectric disc with different value of steel ball mass.

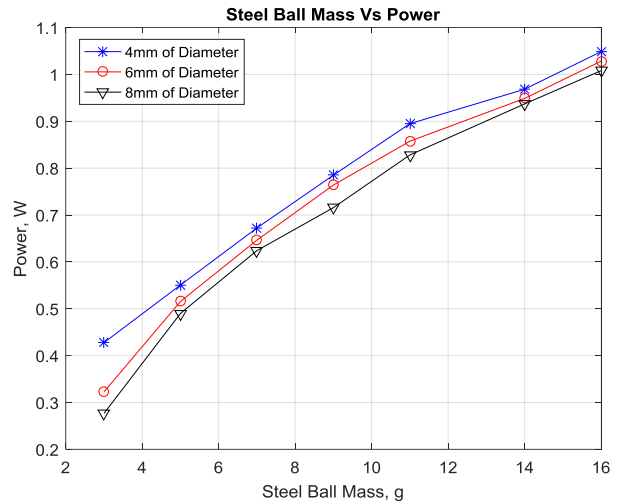

Figure 17: Output power of the piezoelectric disc with different value of steel ball mass.

This is believed that it is due to the lower the height of the interfaced plate, the smaller the amount of the deformation of an interfaced plate. Therefore, the impact force will be higher as the equation (8) which is $F = 2mg \left(\frac{h}{\epsilon L} + 1 \right)$ dedicates that the amount of the deformation of an interfaced mechanism, u or ϵL is inversely proportional to the impact force. The result shows that the output voltage is decreased fiercely when the height of the interfaced plate is increased from 1mm to 4mm. Then, the output voltage is decreased slightly when the height of the interfaced plate is increased from 5mm to 9mm.

A plotted Figure 15 illustrated the height of the interfaced plate versus output power. Same as Figure 14, the output power is inversely proportional to the height of the interfaced

plate. The highest output power is 615mW when the 1mm height and 4mm of the diameter of the interfaced plate is used. Thus, these figures demonstrate that the height of the interfaced plate can also be used to affect the amplitude of the output voltage and power.

Then, the free fall experiment is conducted by varying the value of the steel ball mass. The values of the steel ball mass are 3g, 5g, 7g, 9g, 11g, 14g, and 16g. The height of the steel ball dropped is fixed at 70mm, and the load resistor is 10kΩ. The variations of the interfaced plate diameters are 4mm, 6mm and 8mm. While, the height of the interfaced plate is fixed at 5mm. The output voltage and output power based on

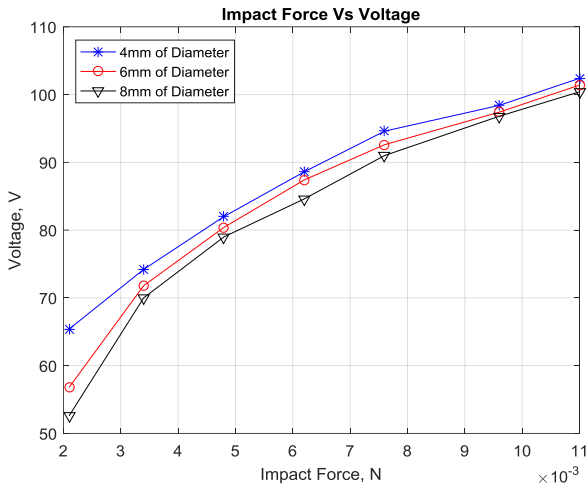

Figure 18: Output voltage of the piezoelectric disc with different value of impact force.

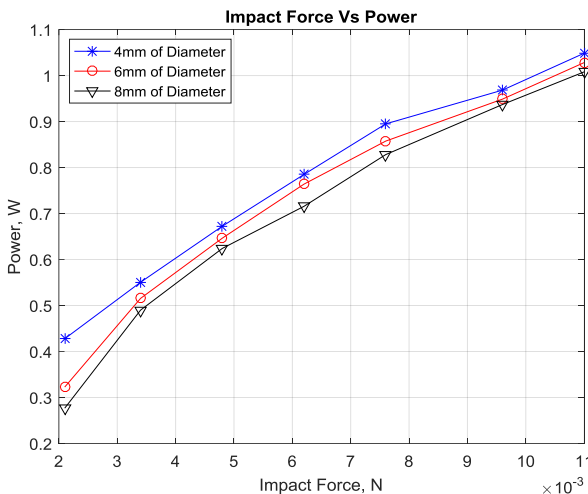

Figure 19: Output power of the piezoelectric disc with different value of impact force.

steel ball mass are being measured and recorded in Figure 16 and 17. Figure 16 shows that the higher the steel ball mass, the higher the output voltage yielded by the piezoelectric. As the $F \propto m$ and $\sigma \propto F$, which $\sigma = \frac{F}{A}$, where F is impact force, m is steel ball mass, σ is referred to stress and A is referred to cross-sectional area. So that the proportionality of the steel ball mass variable to the voltage and power is acceptable. Figure 17 illustrated that the output power is proportional to the steel ball mass. The highest output power is 1.05W when a 16g of steel ball and 4mm of interfaced plate diameter are used. From Figure 16 and 17 show that the differences of the output voltage and output power with different diameters of the interfaced plate

is larger when using the 3g of steel ball mass compared to the 16g of steel ball mass.

As the equation $F = mgh$, the impact force can be determined. Figure 18 and 19 show the plot of the output voltage and output power versus impact force with the certain value of the mass of steel ball dropped. The impact force is varying from 0.002N to 0.011N. The equation shows that the higher the steel ball mass, the higher the impact force. As the equation of $P = F \times v$, where v is referred to the instantaneous velocity. Therefore, theoretically, the output voltage and output power are directly proportional to the impact force. These relationships are illustrated in Figure 18 and 19 below.

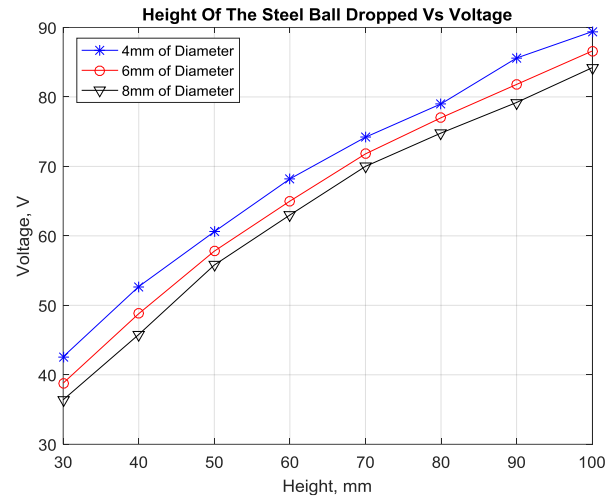

Figure 20: Output voltage of the piezoelectric disc with the variations of height of the steel ball dropped.

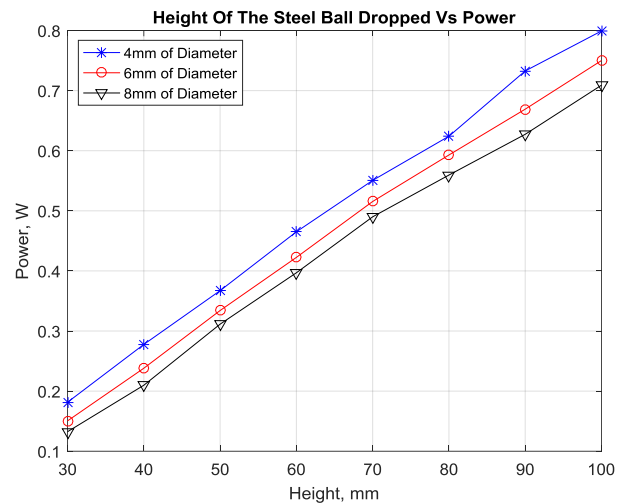

Figure 21: Output power of the piezoelectric disc with the variations of the height of the steel ball dropped.

Next, Figure 20 and 21 illustrated the plot of the output voltage and power versus the height of the steel ball mass dropped. The heights of the steel ball mass dropped are 30mm, 40mm, 50mm, 60mm, 70mm, 80mm, 90mm, and 100mm. The steel ball mass is fixed at 5g. The piezoelectric disc is connected to the 10kΩ load resistance. The diameters of the interfaced plate are 4mm, 6mm, and 8mm, while the height of the interfaced plate is fixed at 5mm. The relationship between the height of the steel ball drop and the output voltage is shown in Figure 20. The output voltage is directly proportional to the height of the steel ball dropped. As the $F \propto h$ and $\sigma \propto F$, which $\sigma = \frac{F}{A}$, where F is impact

force, h is the height of steel ball dropped, σ is referred to stress and A is referred to cross-sectional area. So that the proportionality of the height of the steel ball mass dropped variable to the voltage and power is admissible.

The output power against the height of the steel ball dropped is calculated and plotted in Figure 21. This figure demonstrated that the higher the steel ball dropped, the higher the value of the output power yielded. The highest output

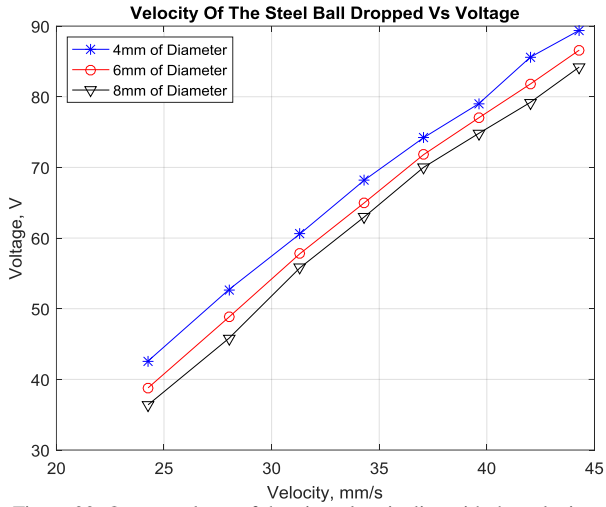

Figure 22: Output voltage of the piezoelectric disc with the velocity of the steel ball dropped.

power is 799mW when 4mm of interfaced plate diameter is utilized, and 100mm height of the steel ball dropped.

Due to $v = \sqrt{2gh_1}$, the higher the height of the steel ball dropped, the higher the value of the steel ball velocity dropped. As mention before that $P = F \times v$, the instantaneous power is directly proportional to the

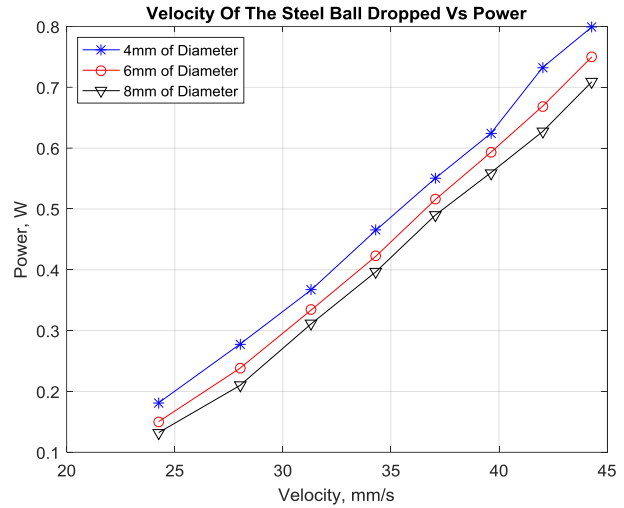

Figure 23: Output power of the piezoelectric disc with the velocity of the steel ball dropped.

Table 2
The Relationship Among the Different Parameters to the Performance of the Piezoelectric Disc

Parameters	Output Voltage	Output Power	Relationship	Comment
Load resistance	Without Interfaced Plate: 81V _{max} With Interfaced Plate: 75V _{max}	Without Interfaced Plate: 672mW With Interfaced Plate: 550mW	Output voltage is proportional to the load resistance until certain value then saturation condition.	<ul style="list-style-type: none"> For both output voltage and output power of piezoelectric disc without interfaced plate is higher than the piezoelectric disc with interfaced plate. The maximum output power can be obtained at 10kΩ of load resistance for both piezoelectric disc with and without interfaced plate.
Diameter of the Interfaced Plate	The highest output voltage: 74.2V	The highest output power: 551mW	Output power and voltage are inversely proportional to the diameter of the interfaced plate.	The highest output power and voltage can be harvested by using 4mm diameter of the interfaced plate.
Height of the Interfaced Plate	The highest output voltage: 78.4V	The highest output power: 615mW	Output power and voltage are inversely proportional to the height of the interfaced plate.	The highest output power and voltage can be yielded by utilizing 1mm height of the interfaced plate.
Steel Ball Mass	The highest output voltage: 102.4V	The highest output power: 1.05W	Output power and voltage are proportional to the steel ball mass.	The highest output power and voltage of the piezoelectric disc with interfaced plate can be obtained by using 16g of steel ball mass.
Height of the steel ball dropped	The highest output voltage: 89.4V	The highest output power: 799mW	Output power and voltage are proportional to the height of the steel ball dropped.	The highest output power and voltage of the piezoelectric disc with interfaced plate can be generated by dropping the steel ball at 100mm height.

instantaneous velocity. Therefore, the output voltage and power should be proportional to the velocity of the steel ball dropped. From the equation $v = \sqrt{2gh_1}$, the velocity of the steel ball dropped can be determined by the determined value of the height of the steel ball dropped, h_1 . The velocity of the steel ball dropped is changed from 24.26mm/s to 44.29mm/s. Figure 22 and 23 illustrate the relationship between the output voltage and power with the velocity of the steel ball dropped.

A summary of the relationship among various parameters with the performance and output efficiency of the piezoelectric disc are described in Table 2. By decreasing the diameter of the interfaced plate, the output power of the piezoelectric transducer will be increased. The highest output power of 551mW is harvested when the 4mm of the diameter of the interfaced plate is attached on the piezoelectric disc. Besides that, the output power of the piezoelectric disc will be increased when the height of the interfaced plate is

decreased. The piezoelectric disc can harvest 615mW of output power when the height of 4mm diameter of the interfaced plate is decreased to 1mm height. The output power increased by 11.615% when the 4mm of diameter and 1mm height of interfaced plate is enclosed on the piezoelectric disc. From the table, it shows that by attaching the interfaced plate on the piezoelectric disc, the relationship between the ball mass and height dropped with the output efficiency of the piezoelectric disc is remained the same. The higher the value of the ball mass, the higher the impact force. Generally, the output power of the piezoelectric disc will be increased as well. Same as the height dropped, which the height dropped is proportional to the impact force, and velocity of the ball dropped. Then, the output will be increased as the height dropped is increased. However, the experiment results show that by enclosing the interfaced plate

on the piezoelectric disc, the output power will be decreased for the instantaneous impact force (free fall experiment).

V. CONCLUSION

The influence of the interfaced plate to the performance and output efficiency of the piezoelectric disc has been presented in this paper. An interfaced plate is attached to the piezoelectric disc, and a free fall test was executed as an evaluation method. The results demonstrate and validate that the performance and output efficiency of the piezoelectric disc can be affected by varying the parameters of the diameter and height of the interfaced plate. When the 5g of steel ball was dropped at 70mm height, the piezoelectric disc which attached a 4mm diameter and 1mm height of the interfaced plate was capable to yield 78.4V of the output voltage and 615mW of output power. Although the output power of the piezoelectric disc with the interfaced plate is lower than the piezoelectric disc without interfaced plate, the amount of the output power is considered acceptable for low power portable and wearable smart devices. This interfaced plate configuration is easy to be set up on the sidewalks, floor mats or tennis racquet which imply to be utilized for yielding human action impact energy. Future work will include the designed power generator combines with an interfaced plate for the impact-based piezoelectric energy harvester in order to enhance the power density of the device.

ACKNOWLEDGMENT

The first author would like to thank UTeM Zamalah Scheme for the sponsorship scheme.

REFERENCES

- [1] K. R. Rashmi, A. Jayarama, N. Navin Bappalige, and R. Pinto, "A Review on Vibration Based Piezoelectric Energy Harvesters," *Sahyadri Int. J. Res.*, vol. 3, no. 1, pp. 47–56, 2017.
- [2] Heung Soo Kim, Joo-Hyong Kim, and Jaehwan Kim, "A Review of Piezoelectric Energy Harvesting Based on Vibration," *Int. J. Precis. Eng. Manuf.*, vol. 12, no. 6, pp. 1129–1141.
- [3] MANISH and S. SHARMA, "PIEZOELECTRIC ENERGY HARVESTING IN WIRELESS SENSOR NETWORKS: A REVIEW," *Int. J. Electr. Electron. Data Commun.*, vol. 3, no. 1, pp. 18–22.
- [4] D. H. S. Rastegar Jahangir, "3.2.5 Interfacing Mechanisms for Energy Harvesting from Short-Duration Force and Accelerating/Decelerating Pulses," *Energy Harvesting for Low-Power Autonomous Devices and Systems*. SPIE, 2017.
- [5] K. N. Choi and H. H. Rho, "Continuous energy harvesting method using piezoelectric element," in *2015 IEEE 2nd International Future Energy Electronics Conference (IFEEC)*, 2015, pp. 1–4.
- [6] L. Van Minh, M. Hara, and H. Kuwano, "Lead-Free (K,Na)NbO₃ Impact-Induced-Oscillation Microenergy Harvester," *J. Microelectromechanical Syst.*, vol. 24, no. 6, pp. 1887–1895, Dec. 2015.
- [7] Z. Xu, W. Wang, J. Xie, Z. Xu, M. Zhou, and H. Yang, "An Impact-Based Frequency Up-Converting Hybrid Vibration Energy Harvester for Low Frequency Application," *Energies*, vol. 10, no. 11, p. 1761, 2017.
- [8] M. Ferrari, M. Baù, F. Cerini, and V. Ferrari, "Impact-Enhanced Multi-Beam Piezoelectric Converter for Energy Harvesting in Autonomous Sensors," *Procedia Eng.*, vol. 47, no. Supplement C, pp. 418–421, 2012.
- [9] A. A. Basari *et al.*, "Evaluation on mechanical impact parameters in piezoelectric power generation," in *Control Conference (ASCC), 2015 10th Asian*, 2015, pp. 1–6.
- [10] A. A. Basari *et al.*, "Study of the effect of mechanical impact parameters on an impact-mode piezoelectric ceramic power generator," *Ceram. Int.*, vol. 41, no. 9, Part B, pp. 12038–12044, 2015.
- [11] A. M. Abdal-Kadhim and K. S. Leong, "Piezoelectric impact-driven energy harvester," in *2016 IEEE International Conference on Power and Energy (PECon)*, 2016, pp. 407–411.
- [12] A. M. Abdal and K. S. Leong, "Piezoelectric Pre-Stressed Bending Mechanism for Impact-Driven Energy Harvester," *IOP Conf. Ser. Mater. Sci. Eng.*, vol. 210, no. 1, p. 12037, 2017.
- [13] S. Hashimoto *et al.*, "Evaluation of impact mode-based piezoelectric power generator," in *2016 IEEE 11th Conference on Industrial Electronics and Applications (ICIEA)*, 2016, pp. 1131–1134.
- [14] A. A. Basari, S. Hashimoto, B. Homma, H. Okada, H. Okuno, and S. Kumagai, "Design and optimization of a wideband impact mode piezoelectric power generator," *Ceram. Int.*, vol. 42, no. 6, pp. 6962–6968, 2016.
- [15] M. Renaud, P. Fiorini, R. van Schaijk, and C. van Hoof, "An impact based piezoelectric harvester adapted to low frequency environmental vibrations," in *TRANSDUCERS 2009 - 2009 International Solid-State Sensors, Actuators and Microsystems Conference*, 2009, pp. 2094–2097.
- [16] E. Jacquelin, S. Adhikari, and M. I. Friswell, "A piezoelectric device for impact energy harvesting," *Smart Mater. Struct.*, vol. 20, no. 10, p. 105008, 2011.
- [17] M. A. Halim, H. O. Cho, and J. Y. Park, "A handy motion driven, frequency up-converting piezoelectric energy harvester using flexible base for wearable sensors applications," in *SENSORS, 2015 IEEE*, 2015, pp. 1–4.
- [18] S. Ju and C. H. Ji, "Indirect impact based piezoelectric energy harvester for low frequency vibration," in *2015 Transducers - 2015 18th International Conference on Solid-State Sensors, Actuators and Microsystems (TRANSDUCERS)*, 2015, pp. 1913–1916.
- [19] D. Alghisi, S. Dalola, M. Ferrari, and V. Ferrari, "Triaxial ball-impact piezoelectric converter for autonomous sensors exploiting energy harvesting from vibrations and human motion," *Sensors Actuators A Phys.*, vol. 233, no. Supplement C, pp. 569–581, 2015.
- [20] X. He, K. S. Teh, S. Li, L. Dong, and S. Jiang, "Modeling and experimental verification of an impact-based piezoelectric vibration energy harvester with a rolling proof mass," *Sensors Actuators A Phys.*, vol. 259, no. Supplement C, pp. 171–179, 2017.
- [21] A. M. Abdal-Kadhim, K. S. Leong, and L. K. Tee, "Impact Based Piezoelectric Energy Harvesting: Effect of Single Step's Force and Velocity," *J. Telecommun. Electron. Comput. Eng.*, vol. 8, no. 5, pp. 125–129, 2016.
- [22] N. S. Shenck and J. A. Paradiso, "Energy scavenging with shoe-mounted piezoelectrics," *IEEE Micro*, vol. 21, no. 3, pp. 30–42, May 2001.
- [23] A. M. Abdal-Kadhim, K. S. Leong, and N. Mohamad, "Evaluation of Impact Based Piezoelectric Micro-Power Generator," *J. Telecommun. Electron. Comput. Eng.*, vol. 8, no. 4, pp. 87–89, 2016.
- [24] P. Janphuang, D. Isarakorn, D. Briand, and N. F. de Rooij, "Energy harvesting from a rotating gear using an impact type piezoelectric MEMS scavenger," in *2011 16th International Solid-State Sensors, Actuators and Microsystems Conference*, 2011, pp. 735–738.
- [25] P. Janphuang, R. A. Lockhart, D. Isarakorn, S. Henein, D. Briand, and N. F. de Rooij, "Harvesting energy from a rotating gear using an AFM-like MEMS piezoelectric frequency up-converting energy harvester," *J. Microelectromechanical Syst.*, vol. 24, no. 3, pp. 742–754, 2015.
- [26] F. S. W. R. E. F. B. W. Patrick Dale R., "2.8.4 Conservation of Energy," *Energy Conservation Guidebook (3rd Edition)*. Fairmont Press, Inc., 2014.
- [27] T. W. Kerlin, "2.4 Units of Measure," *Future Energy - Opportunities and Challenges*. ISA, 2013.
- [28] H. Y. C. C. Li Guangfan, "737.3 Combined Convection and Radiation Boundary Condition," *Advanced Building Materials*. Trans Tech Publications Ltd, 2011.