

Investigation of Human Pathogen Using Electronic Nose for Early Diagnosis

Syahida Amani Zulkifli, Che Wan Sharifah Robiah Mohamad, Abu Hassan Abdullah
School of Mechatronic Engineering, Universiti Malaysia Perlis (UniMAP), 02600 Arau, Perlis, Malaysia
syahidaamanizulkifli@yahoo.com

Abstract— Electronic nose (E-nose) known as gas sensor array is a device that analyze the odor measurement give the fast response and less time consuming for clinical diagnosis. Many bacterial pathogens could lead to life threatening infections. Accurate and rapid diagnosis is crucial for the successful management of these infections disease. The conventional method need more time to detect the growth of bacterial. Alternatively, the bacteria are *Pseudomonas aeruginosa* and *Shigella* cultured on different media agar can be detected and classifies according to the volatile compound in shorter time using electronic nose (E-nose). Then, the data from electronic nose (E-nose) is processed using statistical method which is principal component analysis (PCA). The study shows the capability of electronic nose (E-nose) for early screening for bacterial infection in human stomach.

Index Terms— Bacterial infection; Electronic nose; Principal component analysis (PCA); Sensor.

I. INTRODUCTION

In contemporary medicine, early screening of bacteria present in infections is very crucial. With the increase of patients nowadays, there is demand for rapid, accurate and non-invasive diagnostic tools. It is not only able to detect the type of infection but at the same time, it will be reduce the growth phase into a short period of time (hours) [1]. Classical bacterial identification methods based on culture such as Gram-stain are time-consuming, need specific techniques and expertise [2]. However, to reduce time consuming, a number of alternative techniques are being devised[3]. One non-invasive which is gaining interested for analysis of odor measurement and volatile organic compound for medical use is gas sensor array which is electronic nose (E-nose). This technology has been used to diagnose the odors emitted from human body such as breath, wounds, and body fluids [4].

Bacterial infection is common problem that may develop risk to human if it not be treated. Bacteria itself produce a range of volatile organic compound (VOCs). VOCs are thought to evolve as products or by products of metabolic pathways for example the generation of hydrocarbon, aliphatic alcohols and ketones from fatty acids biosynthesis [5]. The different types of bacteria can cause gastroenteritis are *Staphylococcus aureus*, *Escherichia coli* (*E.coli*), *Pseudomonas aeruginosa*, *Shigella*, *Salmonella* and *H.pylori* [6]. For microbiological detection, the standard method are biopsy culture. Biopsy culture techniques is invasive that need culture the specimen from human stomach. It is cause inconvenient for the patients. The result for the detecting infection take more than two days. It is may cause suffer to the patients that need urgent medical diagnosis and also will costing a lot of money.

Therefore, the aim of this study is to investigate the ability if electronic nose to classify the bacteria in different culture media. The expression electronic nose (E-nose) is an electronic system that tries to imitate the structure if human nose that sense the smell, sent the information to the brain and interpret the specific odorant detected [7]. The sensor array in electronic nose composed of different sensors that chosen to respond to wide range of different chemical in order to discriminate diverse mixture of possible analytes [8]. With the advancement of electronic nose, a small size array for detection of more chemicals with lower cost, higher predictive, accuracy and portability becomes more desired objective and as instrumental analysis [9]. This paper conducts the analysis of bacterial detection as an early screening using electronic nose and proves that electronic nose has ability to classify the bacteria culture din different media agar.

II. MATERIAL AND METHOD

A. Media Culture Preparation

In this experiment, there are two types of culture media for both *Pseudomonas aeruginosa* and *Shigella* were used for the growth of bacteria such as MacConkey agar and Nutrient agar. Preparation of agar media plate must be in clean place and prepared as follows:

1) Preparation of MacConkey's agar

MacConkey agar was prepared using 25 g MacConkey agar powder and mixed with 300 ml of distilled water. Then, the solution was heated on hot plate to make sure agar powder are dissolved before tilled up onto the bottle until 500 ml of distilled water (dH₂O). After the solution completely dissolved, it must put onto an autoclave for sterilization at 121°C. An autoclave used to sterilize equipment supplies by exposed them to high pressure saturated steam at 121 °C (249°F) for around 15–20 minutes depending on the size of the load and the contents [10]. After that, 25ml of the agar solution is poured onto petri dishes. MacConkey agar is used for isolation of gram negative rod and inhibits the growth of gram positive cocci [11].

2) Preparation of Nutrient agar

Nutrient agar are prepared using 10 g Nutrient agar powder and mixed with 300ml of distilled water. Then, the solution was heated on hot plate to make sure all agar powder is dissolved as shown in Figure 3.4 before tilled up the bottle until 450 ml of distilled water (dH₂O). The agar solution need put onto autoclave at 121°C for sterilization. After completely sterile in the autoclave, the agar solution

must be cooled within 15 minutes at 45°C poured 25ml of agar solution onto each petri dish. Nutrient agar is recommended for cultivation of non-fastidious microorganisms [12].

B. Bacteria Sample Preparation

Bacteria samples that have been used are *Pseudomonas aeruginosa* and *Shigella*, The bacterial is cultured onto agar plate using cotton swab. Culture media means the process of bacterial or other biological entity in a medium plate. A cotton swab is used when spreading bacteria over a solid medium. The petri dishes are labeled and sealed. Then, the agar plates are incubated for 24 hours at 37°C. The main purpose of incubation is to provide a suitable environment for the growth of bacteria. A temperature of 37°C is the optimum temperature for the bacteria from human gut to grow and it is commonly used as the constant temperature for the hospital incubators.

C. Sampling Procedure

The sampling method began after the bacteria have been incubated in media culture within 24 hours. The function of the sampling system is to transfer the headspace from sample to the sensors. The Insniff electronic nose is a device used to sniff the samples using headspace of samples to the sensors without changing its composition and properties. For sampling process it is applied traps and purge technique. For the “Purge Cycle”, ambient air supply the chamber inlet to clean the sensors. After completion the “Purge Cycle”, the system will be set to idle state to enable the sensors to return to their baseline values. The “Sniff Cycle” follows, and the indoor air sample was supplied to sensor arrays through the chamber inlet. For each experiment, the empty agar media for MacConkey agar and Nutrient agar also were sniffed and the results as a reference. Figure 1 shows the setup of Insniff electronic nose for sampling data. For each experiment, the empty agar media for MacConkey agar and Nutrient agar also were sniffed and the results as a reference. Figure 1 shows the setup of Insniff electronic nose for sampling data.

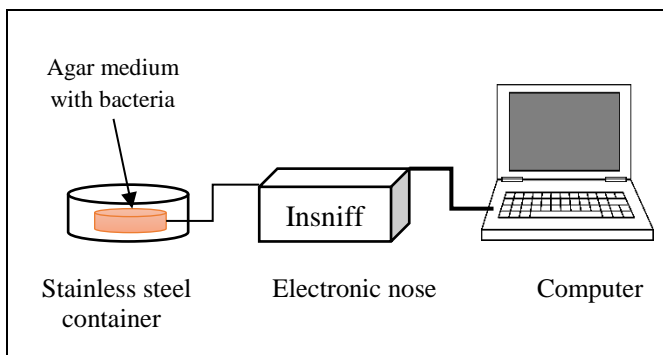

Figure 1: Electronic nose setup for sampling procedure

III. RESULT AND DISCUSSION

The Insniff electronic nose is a device used tool to detect the presence of odor. Research in this field has been driven by various factors during conventional practices. In this experiment, E-nose is a device for detecting odors and gaseous from bacterial. It is consist of ten sensors metal oxide semiconductors (MOS) with two auxiliary sensors for

the temperature and humidity because of MOS gas sensors sensitive to ambient and temperature[13]. Metal oxide semiconductor consist three layers: a silicon semiconductor, a silicon oxide insulator and a catalytic metal through which the applied voltage creates an electric field [4]. The advantages of metal oxide semiconductors are low cost, high sensitivity, fast response/recovery time, ease of use, low maintenance and ability to detect large number of gases [13].

Figure 2(a) and Figure 2(b) represent the sensor response or output from Insniff electronic nose for *Pseudomonas aeruginosa* in different culture media after incubated for 24 hours. The graphs shows the comparison between response of twelve sensors for each types of bacteria in different culture media and two blank agar as control (MacConkey agar and Nutrient agar). The data obtained based on the difference reference sensor response (R) and sample sensor response (R0). The reference normally is the ambient air. Different types of bacteria shows the different sensor response. The pattern of graph shows the differences because of each types of bacteria produce different odor.

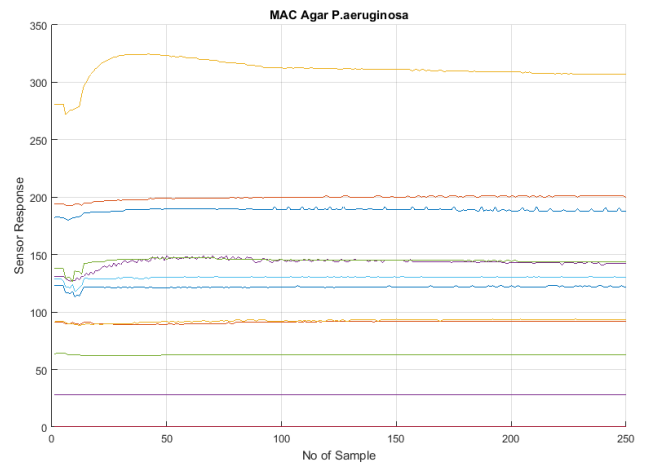

Figure 2(a): Sensor response for *Pseudomonas aeruginosa* on MaConkey agar media

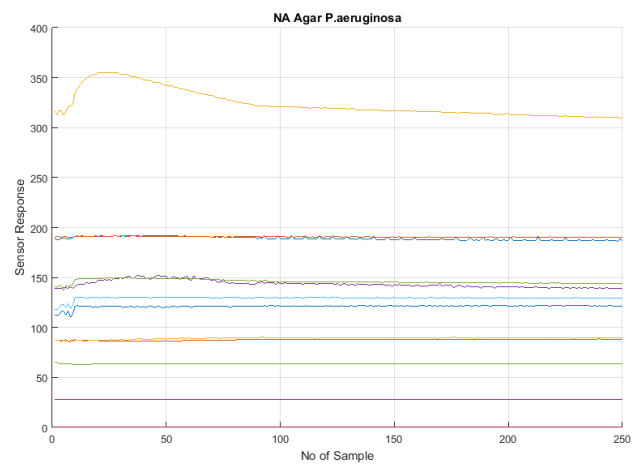

Figure 2(b): Sensor response for *Pseudomonas aeruginosa* on Nutrient agar media

Figure 3(a) and Figure 3(b) represent the sensor response or output from Insniff electronic nose for *Shigella* in different culture media after incubated for 24 hours while

Figure 4(a) and Figure 4(b) represent the sensor response or output from Insniff electronic nose as blank agar (MacConkey agar and Nutrient agar).

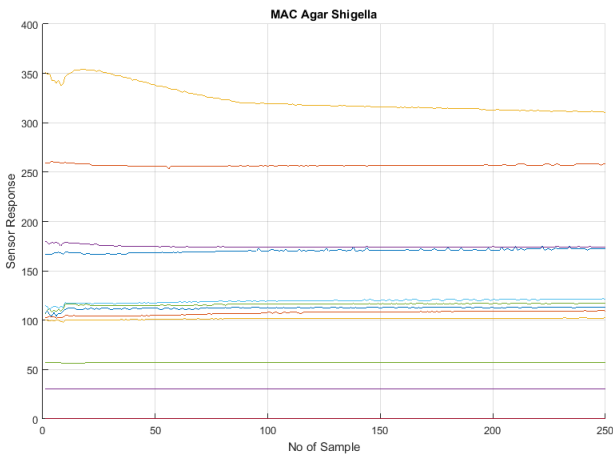

Figure 3(a): Sensor response for *Shigella* on MacConkey agar media

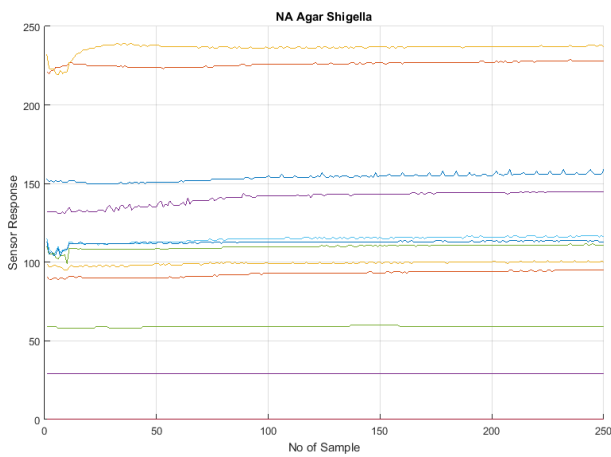

Figure 3(b): Sensor response for *Shigella* on Nutrient agar media

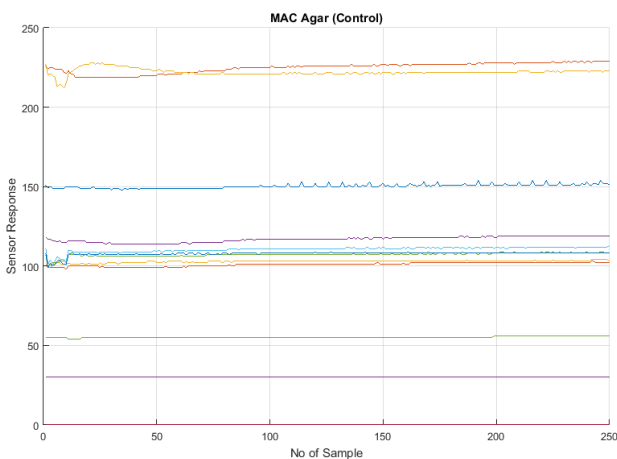

Figure 4(a): Sensor response for blank MacConkey agar media as control

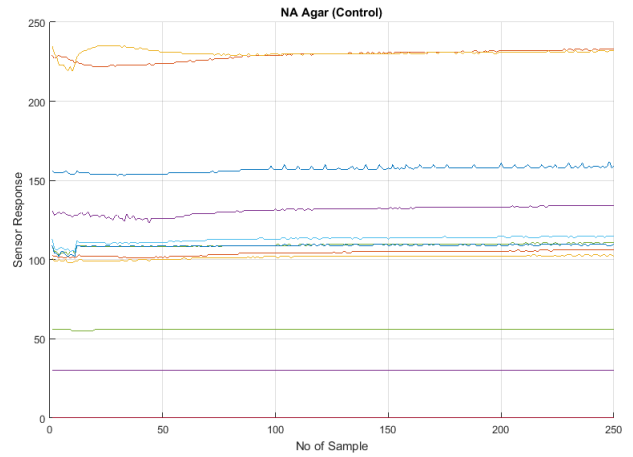

Figure 4(b): Sensor response for blank Nutrient agar media as control

Furthermore, the capability of the Insniff electronic nose in detecting odor produced by each types of bacteria using different culture media were analyzed using Principal Component Analysis (PCA) as shown in Figure 5. Principal Component Analysis (PCA) is statistical method where the transformation actually projects the multidimensional data into coordinates that maximize the variance while minimizing the correlation in the dataset [14], [15].

Since the objective of this experiment is to investigate the ability of electronic nose in classifying the bacteria odors in different agar, so the data analysis will be patterned according to the different culture media. Figure 3(a) shows PCA plot of *Pseudomonas aeruginosa* in both agar which are MacConkey agar (blue label), Nutrient agar (yellow label), blank agar for MacConkey agar (red label) and blank agar for Nutrient agar (black label). The PCA plot for *Pseudomonas aeruginosa* in both agar indicates that principal component 1 is 97.84% and principal component 2 is 1.41% of total variance with 99.25%. For the PCA plot *Shigella* bacterium, the total variance is 98.22% which is 96.00% for principal component 1 and 2.22% for principal component 2. PCA plot shows the early clustering of the each types of bacteria in different culture media as shown in Figure 5(b).

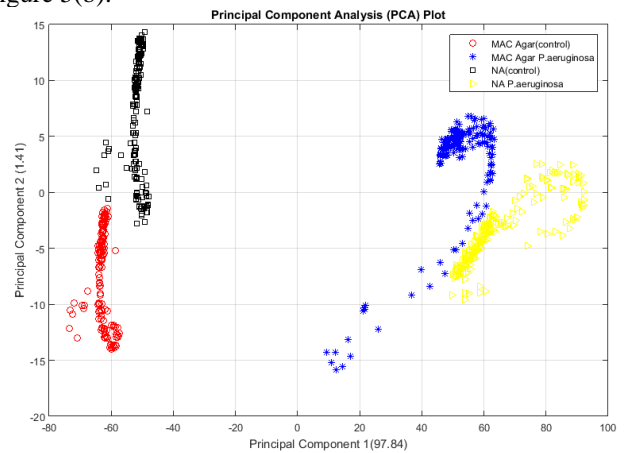

Figure 5(a): PCA plot for *Pseudomonas aeruginosa* in both agar (MacConkey agar and Nutrient agar)

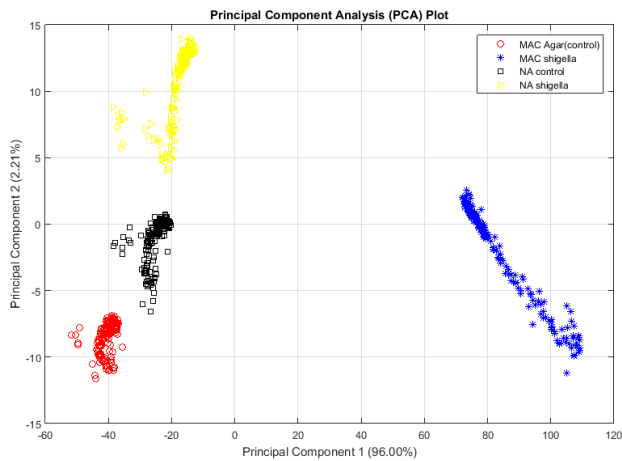

Figure 5(b): PCA plot for *Shigella* in both agar (MacConkey agar and Nutrient agar)

Besides that, the capability of electronic nose is investigated by integrated all culture media in one global plot as shown in Figure 6. The principal component 1 explained 77.30% and for principal component 2 explained 20.69%. The PCA plot shows clear separation among the culture agar in each bacteria. Besides achieving clear separation, *Shigella* bacterium in Nutrient agar was overlapped with blank agar may be due to bacteria not completely growth and cause the odor that released from *Shigella* bacterium is same with blank agar (control agar).

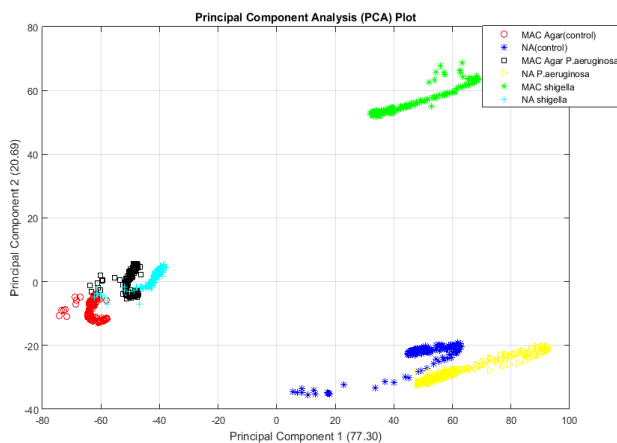

Figure 6: PCA plot for *Pseudomonas aeruginosa* and *Shigella* bacterium in one global plot

IV. CONCLUSION

The findings of this study was to determine whether bacteria in human stomach produce odors that electronic nose sensors can detect. Therefore, electronic nose technology has capability to cluster different bacteria groups using different culture media for bacteria growth. This result will be used in further studies to optimize the number of sensor and find the classifier for good accomplishment. In future study, it will be use others bacteria in human stomach

that targeted for gastrointestinal disease in different culture media.

ACKNOWLEDGMENT

This work is supported by the Fundamental Research Grant Scheme (FRGS) grant 9003-00512 by the Ministry of Higher Education, Malaysia. The author would like to thank all the research fellows involved in this project especially from School of Mechatronic Engineering, Universiti Malaysia Perlis (UniMAP), Arau, Malaysia.

REFERENCES

- [1] T. M. A. Sabeel, F. K. CheHarun, S. E. Eluwa, and S. M. A. Sabeel, "Detection of volatile compounds in urine using an electronic nose instrument," in *2013 International Conference On Computing, Electrical And Electronic Engineering (ICCEEE)*, 2013.
- [2] N. M. Zetola, C. Modongo, K. Mathlagela, E. Sepako, O. Matsiri, T. Tamuhla, B. Mbongwe, E. Martinelli, G. Sirugo, R. Paolesse, and C. Di Natale, "Identification of a large pool of microorganisms with an array of porphyrin based gas sensors," *Sensors (Switzerland)*, vol. 16, no. 4, pp. 1–14, 2016.
- [3] J. Heo and S. Z. Hua, "An overview of recent strategies in pathogen sensing," *Sensors (Switzerland)*, vol. 9, no. 6, pp. 4483–4502, 2009.
- [4] A. A. Abdullah, N. Yusuf, A. Zakaria, M. I. Omar, A. Y. Shakaff, A. H. Adom, L. M. Kamarudin, Y. E. Juan, A. Othman, and M. S. Yassin, "Bacteria Classification Using Electronic Nose for Diabetic Wound Monitoring," *Appl. Mech. Mater.*, vol. 339, no. July, pp. 167–172, 2013.
- [5] E. Tait, J. D. Perry, S. P. Stanforth, and J. R. Dean, "Identification of Volatile Organic Compounds Produced by Bacteria Using HS-SPME-GC – MS," pp. 363–373, 2014.
- [6] "Bacterial Gastroenteritis Medication," pp. 2–5, 2017.
- [7] N. Yusuf, M. I. Omar, A. Zakaria, A. I. Jeffree, R. Thriamani, A. A. Abdullah, A. Y. M. Shakaff, M. J. Masnan, E. J. Yeap, A. Othman, and M. S. Yassin, "Evaluation of E-nose technology for detection of the causative bacteria in different culture media on diabetic foot infection," *IECBES 2014, Conf. Proc. - 2014 IEEE Conf. Biomed. Eng. Sci. "Miri, Where Eng. Med. Biol. Humanit. Meet."*, no. July, pp. 67–70, 2015.
- [8] A. Dan Wilson, "Advanced methods for teaching electronic-nose technologies to diagnosticians and clinical laboratory technicians," *Procedia -Social Behav. Sci.*, vol. 46, pp. 4544–4554, 2012.
- [9] L. Zhang, F. Tian, and G. Pei, "A novel sensor selection using pattern recognition in electronic nose," *Measurement*, vol. 54, pp. 31–39, 2014.
- [10] W. B. Hugo, "A brief history of heat, chemical and radiation preservation and disinfection," *Int. Biodeterior. Biodegrad.*, vol. 36, no. 3–4, pp. 197–217, 1995.
- [11] V. O. Ifeanyi, S. C. Nwosu, J. O. Okafor, C. P. Onnegbu, and N. E., "Comparative studies on five culture media for bacterial isolation," *African J. Microbiol. Res.*, vol. 8, no. 36, pp. 3330–3334, 2014.
- [12] R. Arulanatham, S. Pathmanathan, N. Ravimannan, and K. Niranjan, "Alternative culture media for bacterial growth using different formulation of protein sources," *J. Nat. Prod. Plant Resour.*, vol. 2, no. 6, pp. 697–700, 2012.
- [13] J. Gutiérrez and M. C. Horrillo, "Talenta Advances in artificial olfaction : Sensors and applications," vol. 124, pp. 95–105, 2014.
- [14] M. B. Banerjee and T. Nandy, "Multivariate Preprocessing Techniques Towards Optimising Response of Fused Sensor from Electronic Nose and Electronic Tongue," pp. 949–954, 2016.
- [15] M. J. Masnan, A. Zakaria, A. Y. M. Shakaff, N. I. Mahat, H. Hamid, N. Subari, and J. M. Saleh, "Principal Component Analysis – A Realization of Classification Success in Multi Sensor Data Fusion," *Principal Component Analysis Application.*, pp. 1–25, 2012.