

Performance of Different Mach-Zehnder Interferometer (MZI) Structures for Optical Modulator

Nur Hidayah S, Hanim A.R, Hazura H, S.K. Idris, A.S. Mohd Zain, F. Salehuddin, Afifah Maheran A.H
Centre for Telecommunications Research Innovations (CETRI), Faculty of Electronic & Computer Engineering,
Universiti Teknikal Malaysia Melaka, Melaka, Malaysia
hidayahsbo@gmail.com

Abstract—An optical modulator is a device that electrically controls the output phase and the output amplitude of the optical signal. This paper analyzes the performance of different structures of the MZI as an optical modulator. This project compares the performance of Y-coupler and MMI coupler as Mach-Zehnder Interferometer (MZI) modulator on the Silicon-On-Insulator (SOI). This project used OptiBPM software and OptiSys for designing the structures and performance analysis. The performance has been analyzed based on the insertion loss, extinction ratio, phase shift and modulation efficiency. MMI-coupler design shows better performance with reduced insertion loss and better modulation efficiency of 2.53% and 17% respectively than that of the Y-coupler. Furthermore, the extinction ratio and phase shift of MMI coupler show an increment about 8.35% and 7.96% respectively when analyzed as the optical modulator. Therefore, the MMI coupler as MZI modulator exhibits better performance than the Y-coupler.

Index Terms—MZI; Optical Modulator; Power Splitter; MMI-Coupler; Y-Coupler; SOI.

I. INTRODUCTION

The optical modulator is a device which is able to modulate and vary the optical signal in a controlled manner [1]. Optical modulator can be categorized as a phase modulator, amplitude modulator and frequency modulator based on their characteristics [2].

Phase Modulator is a device which is located on one arm of MZI optical modulator [3]. The phase modulator changes the refractive index of the material. Therefore, the phase optical signal that passes through it will change [4].

MZI modulator interference happens when two or more optical waves are present simultaneously in the same area [5]. The interferometer is an optical device that has the ability to splits a single signal into several signals by using the beam splitter and then it can combine together back [6]. Y-coupler and MMI-coupler are among the famous coupler used as the MZI modulator structures. The phase modulator which changes the refractive index of the material changes the phase of the signal wave passing through the device [7]. When the signal arrives at the output, the phase and amplitude of the signal will be modulated [8].

A power splitter is one of the essential components in designing an MZI optical modulator [9]. Power splitter can be used as the coupler device and combiner device. The device distributes the optical signal from a single waveguide into branches [10]. The structure of Y-coupler contains curvature meanwhile the MMI coupler offers less bending

line. Figure 1 shows a diagram of both couplers [11].

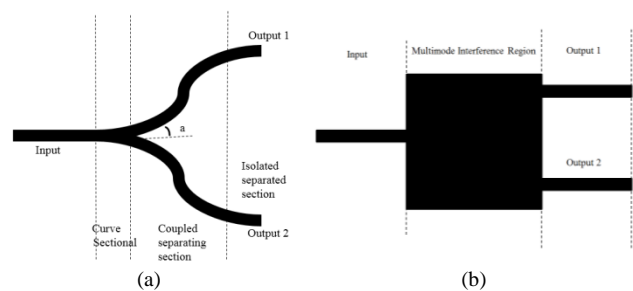

Figure 1: (a) Y-coupler diagram, (b) MMI-coupler diagram

A common material used for the phase modulator is silicon that can be realized by using the free carrier dispersion effect [12]. Silicon photonic devices have been extensively studied due to fabrication techniques that can be largely exploited to fabricate low-loss, low-cost and high volume optical integrated devices [10]. A semiconductor material has the ability to allow the electrical passes through it after doping process of the insulator layer [13]. SOI materials are currently reported to be the more suitable substrates for multiple applications because of the low-power and low-voltage characteristics [14]. Photonic devices such as a splitter, coupler, and filter have been demonstrated in silicon but once the device has been fabricated, the properties of the device are predetermined [15]. A silicon based modulator can be used to control the flow of light, where the refractive index of the silicon waveguide can be varied [16]. Thus, the induce of refractive index will change the transmission properties.

This project uses PIN structure for the phase modulator on the SOI. Applying this P-I-N structure will shift the phase of light propagate through the active arm. The phase shift of light is the result of the change the refractive index of the active arm [14].

The design process includes the optical coupler device and the different structure for MZI optical modulator. The design methodology was applied according to the order to obtain the best performance of the optical modulator. Meanwhile, the performances of the devices were analyzed by adjusting the structure of the MZI optical modulator. The analysis includes the insertion loss, extinction ratio and modulation efficiency.

The design modeling was done using the OptiBPM and the analysis was done utilizing the OptiSys.

II. OPTICAL MODULATOR DESIGN STRUCTURES

In this paper, there are two designs of the MZI structure that are being studied which includes the formation of MZI using Y-structure and MMI structure. The MZI optical modulator consists of four main blocks which are the input waveguide, phase modulator arm, reference arm and output waveguide [10] as shown in Figure 2 and Figure 3.

Both structures as in [17] been designed. The optical power was applied to the input waveguide. The most critical design is the coupler device as the ratio of the total power of output path for both arms must be equal.

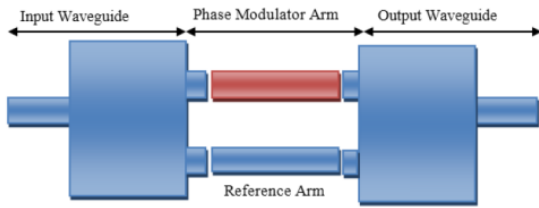

Figure 2: MMI-structure of MZI optical modulator

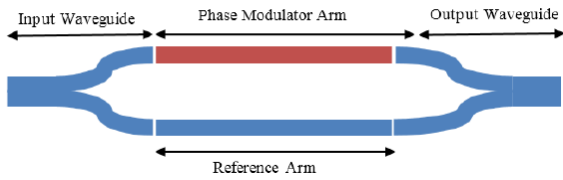

Figure 3: Y-structure of MZI optical modulator

The phase modulator was located on one of the MZI arms. The phase modulator was constructed using the P-I-N injection carrier effect. The supply voltage is 0.9V. The operating wavelength was at 1550nm.

Table 1 tabulates the design parameters of the MMI structure and the Y-structure. The width of the MMI is calculated utilizing Equation (1) [18].

$$L_{MMI} = \frac{4n_0 W_{MMI}^2}{3\lambda_0} \tag{1}$$

Table 1 Design Parameter for the Coupler Device

Design Parameter	MMI Structure	Y-Structure
Input / Output Waveguide	 $W_i: 5\mu m, L_{MMI}: 4285\mu m, W_{MMI}: 38\mu m$	 $W_i: 5\mu m, L_Y: 4285\mu m,$
Reference Arm	 $W_R: 5\mu m, L_R: 700\mu m$	
Phase Modulator (Sensing Arm)	 $W_s: 5\mu m, L_s: 400\mu m$	
Wafer Dimension	Width : 150 μm , Length : 6250 μm	
Wafer Material (Refractive Index)	Passive Material : 3.45, Active Material : 3.43973	

A. MMI-Structure Device

The design of the MMI coupler and MMI combiner were done in OptiBPM. Figure 5 and Figure 6 show the light intensity of MMI-coupler.

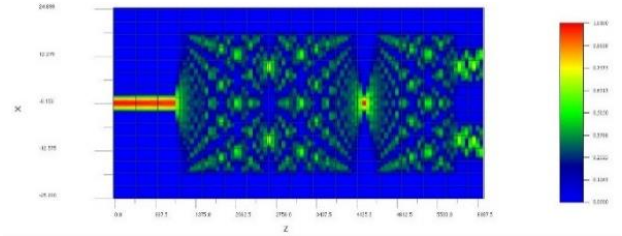

Figure 5: MMI-Coupler optical field intensity in OptiBPM

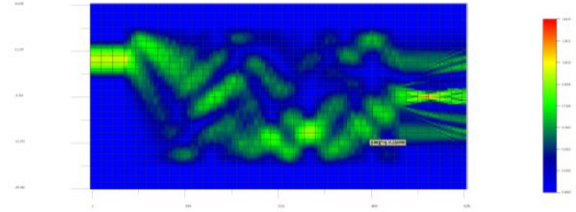

Figure 6: MMI-Combiner optical field intensity in OptiBPM

Figure 7 shows the power ratio in the path of both arms. It shows that the optical power is split equally distributed to the both arms. Power ratio at the input port is 1 and power ratio for each path of the arm is 0.5 respectively.

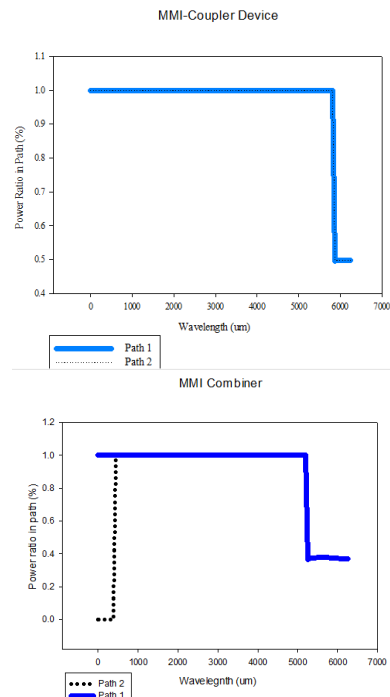

Figure 7: MMI-Coupler and MMI-Combiner power ratio in path

B. Y-Structure Device

Meanwhile, the intensity of the optical field for Y-coupler are shown in Figure 9 and Figure 10.

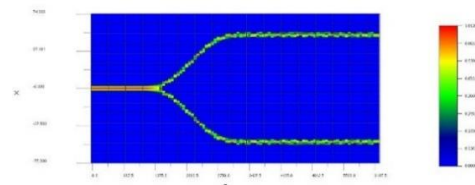

Figure 9: Y-Coupler optical field intensity in OptiBPM

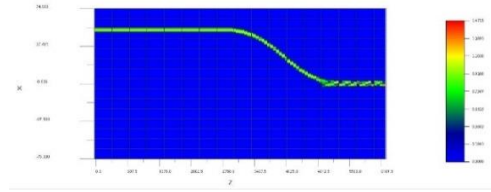

Figure 10: Y-Combiner optical field intensity in OptiBPM

Figure 11 shows the power ratio in the path of both arms. The optical power is split equally to the both arms. Power ratio at the input port is 1 and power ratio for each path of the arm is 0.5 respectively.

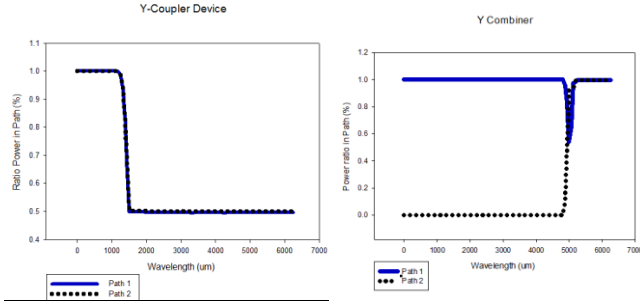

Figure 11: Y-Coupler and Y-Combiner power ratio in path

III. DESIGN STRUCTURES OF MZI OPTICAL MODULATOR

Once the design of the coupler device achieved the 50/50 ratio, the designs were converted to OptiSys to form the MZI modulator. The analysis of the MZI modulator utilizes the OptiSys.

Figure 12 shows the basic configuration of the MZI modulator. The optical filter analyzer acts as the input source of the optical modulator. The initial operating wavelength at 1550nm and the bandwidth set as 20nm. An optical spectrum analyzer located at the output waveguide in order to observe the output waveform produced. Power meters were placed at the input and output waveguide to analyze the amount of the optical power signal.

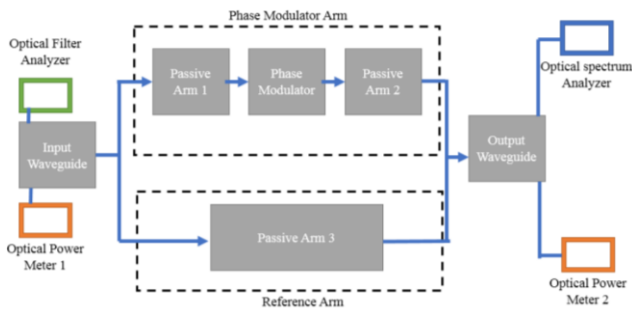

Figure 12: MZI optical modulator circuit diagram

The different of the frequency spectrum of the modulator at applied voltage and 0V is known as $\Delta\lambda$. Free spectral region (FSR) is different at the operating wavelength of two amplitude for the active phase modulator. The final amplitude operating wavelength is (λ_{Av}) and the initial amplitude (λ_{Au}) value. From the optical transmission graph the extinction ratio can be determined by observing the highest and the lowest amplitude of the active phase modulator at the operating wavelength.

The difference of the received power and the input power is known as insertion loss. From the obtained values, the amount of phase shift can be determined by formula $\frac{2\pi\Delta\lambda}{FSR}$ [19] and phase modulation using a formula $V\pi L\pi$ [16].

C. MMI-Structure as MZI Optical Modulator

Figure 13 shows the block diagram of MMI-structure as MZI optical modulator.

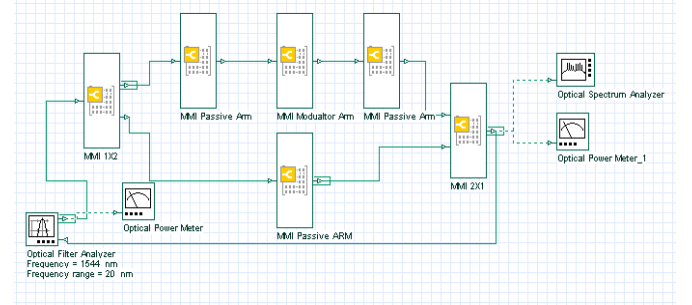

Figure 13: MMI-structure as MZI Optical Modulator in OptiSys

Figure 14 shows the graph of optical transmission for Y-structure as MZI optical modulator. The extinction ratio is labelled as ER, phase shift as $\Delta\phi$ and FSR is free spectral range. FSR has been used in order to get the modulation efficiency. The dotted line represents the optical modulator at an applied voltage of 0.9V, meanwhile, the straight line represents the optical modulator at 0V. All value has been recorded in Table 2.

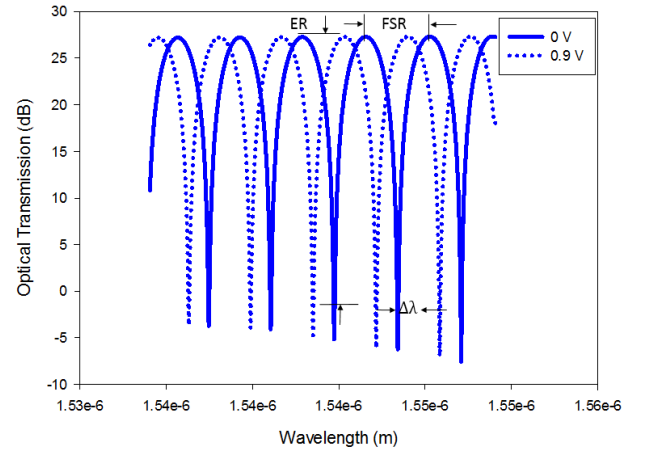

Figure 14: MMI-structure optical transmission

 Table 2
Performances of MMI-Structure as Optical Modulator

Parameter	Formulae	Value
$\Delta\lambda$ (m)	$\lambda_{Av} - \lambda_{Pu}$	1.3×10^{-9}
FSR (m)	$\lambda_{Av} - \lambda_{Au}$	3.61×10^{-9}
ER (dB)	$P_H - P_L$	30.54
IL (dB)	$P_o - P_i$	5.816dB
Phase Shift $\Delta\phi$	$\frac{2\pi\Delta\lambda}{FSR}$	2.26
Modulation Efficiency	$V\pi L\pi$	45.03
	$\lambda\pi: \frac{\Delta\phi\lambda}{2\pi\Delta\lambda}$	

D. Y-Structure as MZI Optical Modulator

Figure 15 shows the block diagram of Y-structure as MZI optical modulator.

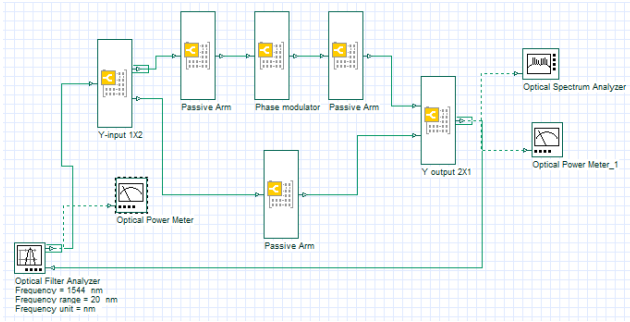

Figure 15: Y-structure as MZI Optical Modulator in OptiSys

Figure 16 shows the graph of optical transmission for Y-structure as MZI optical Modulator. All values have been recorded in Table 3.

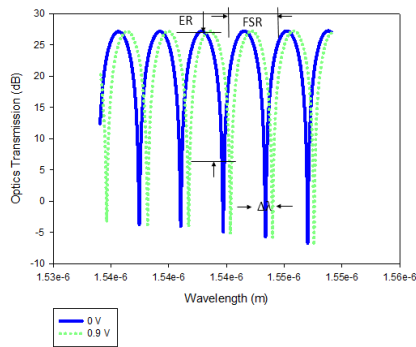

Figure 16: Y-structure optical transmission

Table 3
Performances of Y-structure as Optical Modulator

Parameter	Formulae	Value
$\Delta\lambda$ (m)	$\lambda_{Av} - \lambda_{Pu}$	1.24×10^{-9}
FSR (m)	$\lambda_{Av} - \lambda_{Au}$	3.74×10^{-9}
ER (dB)	$P_H - P_L$	27.99
IL (dB)	$P_o - P_i$	5.816 dB
Phase Shift $\Delta\phi$	$\frac{2\pi\Delta\lambda}{FSR}$	2.08
Modulation Efficiency	$V\pi L\pi, \lambda\pi: \frac{\Delta\phi\lambda}{2\pi\Delta n}$	54.29

IV. MZI OPTICAL MODULATOR PERFORMANCE

Both structures of the MZI optical modulator exhibits different performance. The performances of the optical modulator were analyzed by observing the optical spectrum analyzer and the power meter.

Insertion loss and extinction ratio can be observed through the optical power meter. Phase modulation and phase shift were analyzed as optical transmission in dB units by observing at the optical spectrum analyzer.

The performance of the Y-structure and the MMI structure as the MZI modulator is tabulated in Table 4.

Table 4
Analysis of Y-structure and MMI-structure Characteristic

Parameter	Y-Coupler	MMI
$\Delta\lambda$ (m)	1.24×10^{-9}	1.3×10^{-9}
FSR (m)	3.742×10^{-9}	3.61×10^{-9}
ER (dB)	27.99	30.54
IL (dB)	5.816 dB	5.669 dB
Phase Shift $\Delta\phi$	2.08	2.26
Modulation Efficiency	54.29	45.03

E. Insertion Loss

From Table 4, Y-structure has 5.816 dB while for MMI-structure it has 5.669 dB amount of insertion loss. The MMI structure shows reduced loss of 8.35% than that of the Y-coupler’s response.

F. Extinction Ratio

The MMI structure of the MZI exhibits better extinction ratio than that of the Y-structure with 9.11% percent of increment in terms of performance.

G. Phase Shift

From Table 4, the Y-structure and MMI-structure show the phase shift of 2.08rad and 2.26 rad. Higher phase shift gives a better performance of the device. MMI coupler exhibits 7.96% higher phase shift.

H. Modulation Efficiency

Effect of doping process through the carrier injection can be observed through the modulation efficiency. Modulation efficiency is the product of the length of the modulator and the voltage required to achieve at certain phase shift. Value of modulation efficiency should be lower so that it can enhance the performance of optical modulator. In terms of the modulation efficiency, the MMI structure demonstrates better performance with a lower value of 45.03Vcm.

V. CONCLUSION

In conclusion, the MMI structure of the MZI modulator shows a superior performance compared to the Y-structure. The physical structure of the MMI exhibits low insertion loss, high extinction ratio and good value of modulation efficiency. The findings of this research serve as a vital guidance in designing the optical modulator on SOI.

ACKNOWLEDGEMENT

This paper is supported under RAGS/1/2014/TK03/FKEKK/B00060 grant and UTeM Zamalah Scheme.

REFERENCES

- [1] A. P. K. Reed, Graham T., *An Introduction Silicon Photonics*. Wiley-Interscience, 2004.
- [2] A.-Q. Liu, “Photonic MEMS Devices Design, Fabrication and Control,” 2009.
- [3] B. Mardiana and H. Hazura, “Phase modulator based on silicon-on-insulator (SOI) rib waveguide,” *Photonics (ICP)*, ..., no. 1, pp. 1–3, 2010.
- [4] L. P. Laurent Vivie, *Silicon Photonics Handbook of Handbook of*, 1st ed. CRC Press, 2013.
- [5] H. Kusano, Y. Yanagidate, and H. Uenohara, “Investigation of a Silicon Photonic Optical Serial-to-Parallel Converter With Mach-Zehnder Delay Interferometers and Integrated Ge-PDs,” *IEEE J. Quantum Electron.*, vol. 51, no. 8, pp. 1–9, 2015.
- [6] W. Wang, “Phase Modulation,” vol. 1, pp. 1–68, 2000.
- [7] R. W. Chuang, M.-T. Hsu, Y.-C. Chang, Y.-J. Lee, and S.-H. Chou, “Integrated multimode interference coupler-based Mach-Zehnder interferometric modulator fabricated on a silicon-on-insulator substrate,” *IET Optoelectron.*, vol. 6, no. 3, p. 147, 2012.
- [8] K. Wakita, *Semiconductor Optical Modulators*. New York: SPRINGER-SCIENCE+BUSINESS MEDIA, LLC, 1998.
- [9] Y. Zhang, L. Liu, X. Wu, and L. Xu, “Splitting-on-demand optical power splitters using multimode interference (MMI) waveguide with programmed modulations,” vol. 281, pp. 426–432, 2008.
- [10] G. T. Reed, G. Mashanovich, F. Y. Gardes, and D. J. Thomson,

- “Silicon optical modulators,” vol. 1, no. 1, pp. 1–21, 1993.
- [11] A. Zendeenam, M. Mirzaei, A. Farashiani, and L. H. Farahani, “Investigation of bending loss in a single-mode optical fibre,” *Pramana - J. Phys.*, vol. 74, no. 4, pp. 591–603, 2010.
- [12] H. A. Razak and H. Haroon, “Design and optimization of a Mach-Zehnder Interferometer (MZI) for optical modulators,” pp. 317–320, 2014.
- [13] E. Sinchenko, W. E. K. Gibbs, A. P. Mazzolini, and P. R. Stoddart, “The Effect of the cladding refractive index on an optical fiber evanescent-wave sensor,” *J. Light. Technol.*, vol. 31, no. 20, pp. 3251–3257, 2013.
- [14] J. Boussey, S. Chouteau, and R. Martyrs, “Optoelectronic integration in silicon-on-insulator technologies,” 1998.
- [15] C. E. Png, S. P. Chan, S. T. Lim, and G. T. Reed, “Optical phase modulators for MHz and GHz modulation in silicon-on-insulator (SOI),” *J. Light. Technol.*, vol. 22, no. 6, pp. 1573–1582, 2004.
- [16] B. Mardiana, A. R. Hanim, H. Hazura, S. Shaari, and P. S. Menon, “Electro-optical modulator performance in SOI,” *AIP Conf. Proc.*, vol. 1341, no. 6, pp. 237–240, 2011.
- [17] J. Y. J. Yu *et al.*, “MMI optical couplers and switches with SOI technology,” *Proc. Sixth Chinese Optoelectron. Symp. (IEEE Cat. No.03EX701)*, pp. 1–4, 2003.
- [18] AR. Hanim, B. Mardiana, H. Hazura, and S. Saari, “On the Modulation Phase Efficiency of a Silicon p-i-n Diode Optical Modulator,” (*ICP*)pp. 55–57, 2010.
- [19] A. P. K. Reed, Graham T. *et al.*, “Advances in Photonics for Information and Communication,” vol. 44, no. 0, pp. 1–194, 2003.